

CDL MAPLE SUGARING EQUIPMENT



2017
catalog

word of WELCOME

Dear clients,

CDL is pleased to present, once again, its 2017 catalog. As you go through it, you will see our constant efforts to offer you, year after year, the best product offering of the maple industry.

CDL is proud to be the world leader in the design and manufacturing of high performance equipment for sugaring operations of all sizes. We have the highest standards of quality and performance in the industry. Again and again, we remain faithful to our mission to satisfy you with the significant advantage of bringing together all of your maple syrup services in a single place of business at very competitive prices.

Our passionate employees, the key to our success, are more than ever guided by the desire to offer you a quality service and provide you with a unique experience signed CDL. Small or large, technological or traditional, each project is different. This is why we have the desire to offer you a personalized service that meets your requirements and budget.

Always ahead of the game, due to our technological advances, CDL is now firmly rooted in Quebec, Ontario and the United States. The good health of the industry and our strong growth motivates us to continue developing tools adapted to your needs. Our promise for the next year? To continue to satisfy you, thanks to the expertise of our teams, continuous innovation and the performance of our equipment.

In the name of all the CDL owners, I would like to thank you for your confidence and wish you an excellent sugaring season.

Best regards,

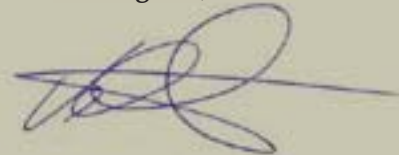

Vallier Chabot



THE UNIQUE CDL EXPERIENCE



A photograph of a winter scene. In the foreground, a green metal roof is visible, heavily laden with snow and long icicles hanging from the eaves. The background consists of a dense forest of bare trees under a bright, overcast blue sky. The overall color palette is dominated by blues, greens, and whites, creating a cold and serene atmosphere.

AN INNOVATIVE VISION IN MAPLE SYRUP PRODUCTION

TABLE OF CONTENT

MAXFLOW fittings	8
3/16" fittings and tubing	10
Spouts	11
Buckets and accessories	14
Stainless steel fittings.	16
Fittings, valves and plumbing.	18
Tubing and mainline	25
ELECTROFUSION fittings.	29
Wire and accessories	30
Tools	31
Monitoring systems	38
Extractors	40
Vacuum booster tanks	43
Vacuum pumps	44
Vacuum pump accessories	46
Gauges and pressure pumps	47
Stainless steel tanks	48
Tanks and accessories	49
Reverse osmosis.	52
Reverse osmosis accessories.	57
Hobby evaporators	61
Wood evaporators	62
Wood, chip or pellet evaporators	66
Oil evaporators	69
Wood pellet evaporators	72
Evaporator accessories	73
Measuring instruments	78
Cleaning accessories	80
Filter presses	82
Filter press accessories	85
Barrels and accessories.	86
Processing equipment.	87
Cans and accessories	91
Bottles and packaging	92
Books	106
Quebec corporate stores, sales representatives and dealers	108
USA corporate stores, sales representatives and dealers	110
Ontario & New-Brunswick corporate stores, sales representatives and dealers	112

Prices and specifications are subject to change without notice.
Taxes not included.



Finally
**SPRING
TIME**

American robins have returned to the region and mild temperatures are expected throughout the week.

Maple sap begins to flow slowly but surely and the tanks will be full within a few days. All the ingredients are there to allow the festivities to begin in the sugar shacks of the region.



TUBING AND FITTINGS

BUCKETS AND ACCESSORIES

*between
tradition and*
**TECHNO
LOGY**

Maple syrup production, in the past was considered artisanal, has developed and is now emerging as a specialized production. Thus, we were able to develop mechanized techniques and modern methods to better organize the Sugar bush, the gathering and processing of the maple sap.

Maple producers can now count on new technological tools, such as camera systems or remote controls, to increase production and, in turn, profitability.

MAXFLOW FITTINGS

The new line of **5/16" Maxflow fittings** was specifically designed and developed for maple producers wanting to operate over 25 in-hg (high vacuum). These fittings enable a perfect seal with a vacuum level **beyond 25 in-hg** and offers the following advantages:

- > **No parting lines on the first barb.**
- > Precision moulding.
- > Eliminates micro leaks caused by molding lines.
- > Better grip on the tubing.

MAXFLOW

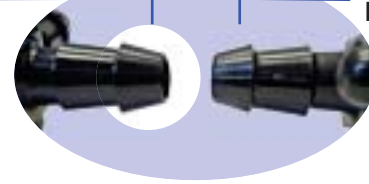

Regular fitting

5/16" MAXFLOW SPOUTS



5/16" black spout with barbs
66090516 \$0.24

We recommend the use of a 19/64" drill bit for tapping.



5/16" white spout with barbs
66090517 \$0.24

We recommend the use of a 19/64" drill bit for tapping.



5/16" white spout without barbs
66090520 \$0.24

We recommend the use of a 19/64" drill bit for tapping.



5/16" blue spout with barbs
66090518 \$0.24

We recommend the use of a 19/64" drill bit for tapping.



5/16" disposable clear spout with barbs
66090519 \$0.24

We recommend the use of a 5/16" drill bit for tapping.

17/64" MAXFLOW SPOUTS



17/64" black spout with barbs
66090514 \$0.24

We recommend the use of a 1/4" drill bit for tapping.



17/64" white spout with barbs
66090515 \$0.24

We recommend the use of a 1/4" drill bit for tapping.



17/64" white spout without barbs
66090512 \$0.24

We recommend the use of a 1/4" drill bit for tapping.



17/64" blue spout with barbs
66090513 \$0.24

We recommend the use of a 1/4" drill bit for tapping.

ACCORDING TO A STUDY

FROM THE ACER CENTER

When comparing sap yield, the white Maxflow spout gave a **sap volume 7% higher** than the black Maxflow spout.

CONCLUSION OF THE STUDY

In the studied sugar bush, white spouts gave a higher volume of sap compared to the black spouts.

This increase, recorded in the last part of the season, would be related to the color of the spout and its thermal absorption properties.

White spouts:
7% better performance



MAXFLOW TEES



5/16" health T
660300099 \$0.29



5/16" T with pin
66301099 \$0.29



NEW
5/16" multi-function T
660300096 \$0.29



5/16" T
with sanitizing cap
66302099 \$0.36
*IDEAL TO SANITIZE WITH
ISOPROPYL ALCOHOL*



17/64" health T
660300098 \$0.30

MAXFLOW END OF LINE ADAPTORS



5/16" end of inline adaptor
66265099 \$0.37



End of line adaptor with cap
66266099 \$0.41

MAXFLOW MULTI-FITTINGS / FIXED HEAD

Hole diameter: 31/64". Screw kit not included



ADVANTAGE
> Larger hole to help with flow

3/4"	66096097	\$2.20
1"	66097097	\$2.35



Screw Kit
66099099 \$0.30

MAXFLOW END OF LINE TEES



5/16" end of line health T
66306357 \$0.30



5/16" end of line T with pin
66305099 \$0.30



5/16" end of line T
with sanitizing cap
66304357 \$0.38
*IDEAL TO SANITIZE WITH
ISOPROPYL ALCOHOL*



17/64" end of line health T
660300097 \$0.30



NEW
5/16" multifunction end T
66306358 \$0.32

5/16" MAXFLOW CONNECTORS



NEW
Round hook connector (5/16" cable)
66011099 \$0.20



5/16" flat hook connector
66303099 \$0.20

MAXSEAL MULTI-FITTINGS / FIXED HEAD

Hole diameter: 31/64". Screw kit not included

ADVANTAGE
> Compressible
gasket for
maximum seal



3/4"	66096096	\$2.20
1"	66097096	\$2.35
1 1/4"	66098096	\$2.80
Maxseal single gasket	66091C	\$0.30



Screw Kit
66099099 \$0.30

3/16" FITTINGS AND TUBING

3/16" FITTINGS



NEW
3/16" clear *Signature* spout \$0.18
66045316



3/16" white spout with barbs \$0.25
66090316

MAXFLOW

We recommend the use of a 19/64" drill bit for tapping



3/16" end of line hook \$0.22
66279357



3/16" flat hook connector \$0.21
66303357



5/16"-3/16" flat hook connector \$0.21
66303356



NEW
3/16" T with pin \$0.30
66030360



NEW
3/16" end line T with pin \$0.34
66030361



3/16"-3/16"-5/16" health T drop line \$0.30
66030355



3/16" health T \$0.30
66030357



3/16" health T end of line \$0.34
66030358



5-16"-5/16"-3/16" health T drop line \$0.30
66030356



5-16"-5/16"-3/16" health T end of line \$0.34
66030359

3/16" TUBING



3/16" CDL Semi-rigid	BLUE	431610021	500'
3/16" CDL Semi-rigid	BLUE	431608221	1 000'
3/16" CDL Flex	BLUE	431610001	500'
3/16" CDL Semi-rigid	GREEN	431608025	500'
3/16" CDL Semi-rigid	GREEN	431608225	1 000'

Ideal pour maple producers using a gravity tubing system.

Ideal for sugarbushes without electricity.

Ideal for maple producers who do not want to use a vacuum system.



Increase your production.

Create a **vacuum effect** without a pump in the 3/16" tubing.

Better sap **quality** than a standard gravity systems.

As **simple** as using buckets, but with less work and better performance.



Signature SPOUTS



NEW
5/16" blue thin wall signature spout
66045063 \$0.18



NEW
5/16" clear thin wall signature spout
66045064 \$0.18



NEW
5/16" green thin wall signature spout
66045067 \$0.18



NEW
1/4" clear thin wall signature spout
66045014 \$0.18



NEW
5/16" light blue thin wall signature spout
66045068 \$0.18



NEW
5/16" red thin wall signature spout
66045065 \$0.18



NEW
5/16" purple thin wall signature spout
66045066 \$0.18

30° DURABLE SPOUTS



30° 5/16" BLACK spout with barbs
66090039 \$0.25
We recommend the use of the 5/16" drill bit for tapping.



30° 5/16" NATURAL spout without barbs
66090042 \$0.25
We recommend the use of the 5/16" drill bit for tapping.



30° 5/16" NATURAL spout with barbs
66090040 \$0.25
We recommend the use of the 5/16" drill bit for tapping.



30° 17/64" BLUE spout with barbs
66090038 \$0.25
We recommend the use of the 1/4" drill bit for tapping.

30° DISPOSABLE SPOUTS



30° 5/16" CLEAR spout without barbs
66090064 \$0.21
We recommend the use of the 5/16" drill bit for tapping.



30° 5/16" CLEAR spout with barbs
66090041 \$0.21
We recommend the use of the 5/16" drill bit for tapping.



30° 17/64" LIGHT BLUE spout without barbs
66090014 \$0.21
We recommend the use of the 17/64" drill bit for tapping.



30° 17/64" LIGHT BLUE spout with barbs
66090015 \$0.21
We recommend the use of the 17/64" drill bit for tapping.

7/16" SPOUTS



7/16" spout
6605309902 \$0.38

STUBBY SPOUT FOR ADAPTOR



Stubby spout Black
66090053 \$0.29

ANTIBACTERIAL SPOUTS



5/16" spout Zap-Bac Antibacterial
Contains silver nanoparticles, approved by Health Canada and the FDA. On request only.
66090094 \$0.45





FITTINGS FOR TUBING

REDUCERS AND ADAPTORS

	7/16" to 5/16" black reducer 66090054	\$0.24		5/16" black spout adaptor 66090099A	\$0.22
<small>Install on stubby spout 66090053.</small>					
	7/16" to 5/16" clear reducer 66090054P	\$0.24		5/16" clear spout adaptor 66090099P	\$0.22
<small>Install on stubby spout 66090053.</small>					
	7/16" to 5/16" natural reducer 66090054N	\$0.24		5/16" natural spout adaptor 66090099N	\$0.23
<small>Install on stubby spout 66090053.</small>					
	7/16" to 5/16" thin wall clear reducer 66090054M	\$0.23		5/16" clear adaptor with thin wall 66090099M	\$0.17
	7/16" to 5/16" black clean spout reducer 66090056	\$0.24		5/16" Zap Bac antibacterial adaptor 66090094A	\$0.32
<small>Not available CLEAR</small>	<small>Install on stubby spout 66090058</small>		<small>Contains silver nanoparticles, approved by Health Canada and the FDA.</small>		

MULTI-FITTINGS / SWIVEL HEAD

	3/4"	66093099	\$1.95
	1"	66094099	\$2.00
	1 1/4" and 1 1/2"	66064099	\$2.25

Hole diameter: 5/16"

MULTI-FITTINGS / PLUG

	3/4" NEW	66094034	\$2.05
	1"	66094091	\$2.30

Ideal to repair holes in mainlines or plug holes when you change the location of a multi-fitting.

Screw kit not included

MULTI-FITTINGS / FIXED HEAD

	3/4"	66096099	\$2.20
	1"	66097099	\$2.30
	1 1/4"	66098099	\$2.65
	Screw kit	66099099	\$0.30

Hole diameter: 5/16". Screw kit not included.

MULTI-FITTINGS / STRAIGHT

	3/4"	66096098	\$2.15
	1"	66097098	\$2.30
	1 1/4"	66098098	\$2.65
	Screw kit	66099099	\$0.30

Hole diameter: 5/16". Screw kit not included.

FITTINGS FOR TUBING

END OF LINE ADAPTORS

	5/16" end of line hook 66279099	\$0.22
	5/16" black Y 66014099	\$0.40
	NEW 3/16" sliding adaptor ERA1510	\$0.40
	5/16" sliding adaptor ETMAT316C	\$0.44
	5/16" sliding hook ETMAT316CH	\$0.26



OTHER

	5/16" Rubber plug 6603509905	\$0.21
	Health spout pin 66012099	\$0.15
	Double forks	
	1/2"	66031099 \$2.50
	3/4"	66032099 \$2.90
	1"	66033099 \$3.95



5/16" CAPS

	5/16" black cap for MaxFlow spouts 66030516	\$0.22		Clear sanitizing universal cap CDL200 <small>*Pieces sold separately. Customer assembly required.</small>	\$0.26
	NEW Clear cap Tip insertion 66030515	\$0.25		NEW 1/4" Clear cap Tip insertion 66030514	\$0.25

SAP LADDER FITTINGS

	5/16" 6-way star 66180 1/2" MIPT	\$1.95
	5/16" 3-way star 66183 1/2" MIPT	\$1.95

5/16" CONNECTORS

	Quick connector 6601209902	\$0.55
	Connector with loops 6601109902	\$0.22

Y / PLASTIC

	INS X INS X INS		
	3/4"	66074099	\$4.25
	1"	66075099	\$4.25
	1" x 1" x 3/4"	66066099	\$4.25
	1" x 3/4" x 3/4"	66067099	\$4.25
	1 1/4" x 1 1/4" x 1"	66034098	\$4.85

PERFECT FOR SPOUT SANITATION

BUCKETS AND ACCESSORIES

BUCKET SPOUTS

	5/16" bucket spout 660551	\$1.10		7/16" Spout without hook Aluminum 660557	\$1.60
	7/16" white bucket spout 66055000A1	\$0.79		5/16" Spout without hook Aluminum 660555	\$1.60
	7/16" Bucket spout Stainless steel 66055S	\$1.50			

BUCKETS AND ACCESSORIES

	NEW 2-gallon grey plastic bucket 663054	\$3.90		Galvanized cover for 2 gallon bucket 66660	\$2.60
				Green plastic cover for bucket 663056	\$3.25
	2 gallon green plastic bucket 663052	\$4.00		Blue plastic cover for bucket 663055	\$3.25
	3 gallon green plastic bucket 663051	\$5.25		Wire for galvanized cover (25/Pkg) LIDWIR	\$6.00
	2 gallon blue plastic bucket 663050	\$4.00		Galvanized bag holder 69BUCKET0102	\$3.25
	2 gallon blue plastic bucket 663053	\$5.25		Blue sap bag 663032	\$0.35

TAPPING STARTER KIT 15 TAPS



Includes:

- 1 short tapping bit 5/16"
- 15 bucket spouts 5/16"
- 15 plastic buckets (2 gallon)
- 15 galvanized bucket covers
- 1 CDL aluminum tapping hammer
- 1 aluminum spout remover (15")

6600800 \$185.00

FITTINGS, VALVES
AND PLUMBING

TUBING, MAINLINE
AND FITTINGS

WIRES
AND ACCESSORIES

MONITORING

EXTRACTORS AND
BOOSTER TANKS

VACUUM PUMPS,
GAUGES AND
PRESSURE PUMPS

TANKS AND
ACCESSORIES

REVERSE OSMOSIS

towards
new

STANDARDS

Did you know that by 2020 all maple syrup producers will have to eliminate all potential lead sources from their maple syrup collection and processing equipment in order to comply with California law applicable throughout Nort America?

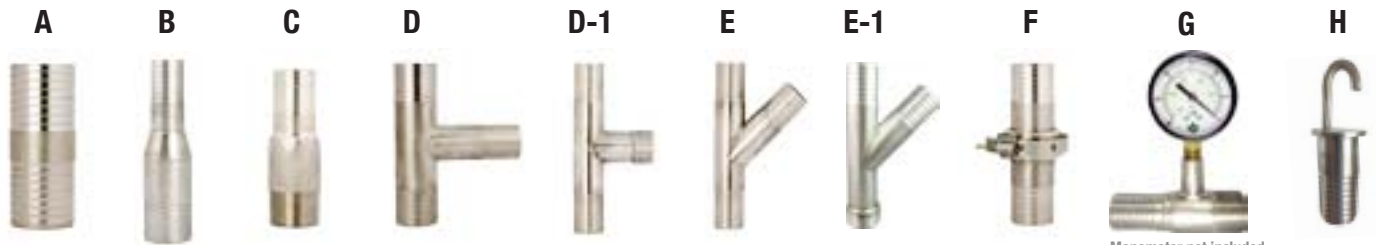

Manometer not included

A- CONNECTORS

INS X INS		
3/4"	662034	\$4.30
1"	662035	\$4.75
1 1/4"	662037	\$5.00
1 1/2"	662038	\$5.20
2"	662039	\$8.90
3"	662033	\$18.95

D- TEES

INS X INS X INS		
1/2"	660503	\$19.95
3/4"	7134341	\$20.35
1"	6607527	\$21.40
1 1/4"	6603106	\$22.40
1 1/2"	6603105	\$24.00
2"	6603108	\$30.55
1" X 1" X 1/2"	66050501	\$23.45
1" x 1" x 3/4"	660505	\$23.45
1 1/4" x 1 1/4" x 1/2"	6605050	\$23.70
1 1/4" x 1 1/4" x 3/4"	660317	\$23.70
1 1/4" x 1 1/4" x 1"	6605061	\$24.00
1 1/2" x 1 1/2" x 3/4"	660507	\$24.45
1 1/2" x 1 1/2" x 1"	660506	\$24.45
1 1/2" x 1 1/2" x 1 1/4"	730312	\$25.00
2" x 2" x 3/4"	660508	\$27.50
2" x 2" x 1"	730311	\$27.50
2" x 2" x 1 1/4"	730314	\$27.50
2" X 2" X 1 1/2"	660511	\$28.00

D- 1

INS X INS X MIPT		
1"	66075251	\$37.70
1 1/2" x 1 1/2" x 1"	730308	\$41.75

B- REDUCERS

INS X INS		
1" x 3/4"	665580	\$15.00
1 1/4" x 3/4"	665586	\$16.80
1 1/4" x 1"	665581	\$17.80
1 1/2" x 3/4"	665587	\$18.15
1 1/2" x 1"	665582	\$18.15
1 1/2" x 1 1/4"	665599	\$18.15
2" x 1"	665596	\$22.40
2" x 1 1/4"	710150	\$24.15
2" x 1 1/2"	665583	\$24.15
3" x 2"	6655302	\$45.90

E- Ys

INS X INS X INS		
1/2"	6607531	\$22.05
3/4"	6607507	\$22.05
1"	6607501	\$24.45
1 1/4"	6607510	\$26.50
1 1/2"	6607508	\$26.50
2"	6607509	\$31.50
1" x 1" x 3/4"	660751	\$25.45
1" x 3/4" x 3/4"	660752	\$34.70
1 1/4" x 1" x 1"	6607511	\$38.70
1 1/4" x 1 1/4" x 3/4"	6607518	\$27.50
1 1/4" x 1 1/4" x 1"	6607512	\$27.95
1 1/2" x 1 1/4" x 1 1/4"	6607515	\$36.95
1 1/2" x 1 1/2" x 3/4"	6607520	\$29.95
1 1/2" x 1 1/2" x 1"	6607516	\$29.95
1 1/2" x 1 1/2" x 1 1/4"	6607505	\$29.95
2" x 2" x 3/4"	6607514	\$31.60
2" x 2" x 1"	6607513	\$31.60
2" x 2" x 1 1/4"	6607519	\$32.60
2" x 2" x 1 1/2"	6607503	\$32.60

E- 1

INS X MIPT X INS		
3/4"	66075124	\$27.50
1"	66075122	\$30.55

C- ADAPTORS

MIPT X INS		
1/2" x 5/8"	710563	\$14.25
3/4"	665589	\$15.05
1"	665592	\$16.30
1 1/4"	665591	\$17.30
1 1/2"	665590	\$19.35
2"	665593	\$25.00
3"	660003	\$81.60

F- QUICK COUPLINGS

COMPLETE SET		
3/4"	662034SS	\$39.75
1"	66201SS	\$40.75
1 1/4"	662014SS	\$45.85
1 1/2"	662012SS	\$68.30
2"	66202SS	\$72.95

INSERTION PART ONLY		
3/4"	736650	\$11.15
1"	736651	\$12.20
1 1/4"	736652	\$13.20
1 1/2"	736655	\$20.35
2"	736656	\$25.45

GASKETS AND COLLARS ONLY (3/4" to 1 1/4")		
Joint	60GASKET112SILI	\$3.60
Collet	60R13VT112	\$15.25

GASKETS AND COLLARS ONLY (1 1/2" to 2")		
Joint	60GASKET2SILI	\$4.05
Collet	60R13VT2	\$16.30

G- VACUUM ADAPTORS

INS X MIPT X FIPT VACUUM		
1 x 1/4"	6655921	\$27.95

NEW

H- HOOK PLUGS

INS		
1"	666801	\$6.95

ADVANTAGES

- > Sharp edges for a solid grip.
- > Precise machining.
- > No restriction.



THREADED STAINLESS STEEL FITTINGS

COUPLINGS



1/4"	6010FC025	\$3.50
3/8"	6010FC0375	\$3.50
1/2"	6010FC05	\$5.90
3/4"	6010FC075	\$7.15
1"	6010FC1	\$10.70
1 1/4"	6010FC125	\$14.35
1 1/2"	6010FC15	\$19.20
2"	6010FC2	\$22.80

TEES



FIPT		
1/4"	712525	\$3.55
3/8"	6010T0375	\$3.90
1/2"	711212	\$4.45
3/4"	713434	\$6.65
1"	711010	\$9.55
1 1/4"	6010T125	\$18.70
1 1/2"	6010T15	\$20.35
2"	6010T2	\$34.35

THREADED PLUGS



FIPT		
1/4"	SCA025	\$4.05
1/2"	SCA050	\$4.60
3/4"	6010BF34	\$4.70
1"	6010BF1	\$5.05
1 1/4"	SCA125	\$8.90
1 1/2"	SCA150	\$11.00
2"	SCA200	\$15.00



MIPT		
1/4"	6010B25	\$2.35
3/8"	6010B38	\$2.60
1/2"	6010B12	\$2.80
3/4"	6010B34	\$3.05
1"	6010B1	\$4.70
1 1/4"	6010B114	\$7.20
1 1/2"	6010B112	\$8.50
2"	6010B2	\$9.75

ELBOWS



90° FIPT X FIPT		
1/4"	6010914	\$4.25
3/8"	601090038	\$4.40
1/2"	601095	\$4.55
3/4"	6010975	\$4.90
1"	6010901	\$10.10
1 1/4"	601090125	\$13.90
1 1/2"	60109015	\$18.60
2"	6010902	\$29.10



90° MIPT X FIPT		
1/4"	6010913	\$3.90
3/8"	6010900375	\$4.70
1/2"	60109S05	\$5.85
3/4"	601090075	\$7.15
1"	601090	\$10.60
1 1/4"	601097	\$17.15
1 1/2"	601096	\$19.90
2"	601092	\$30.15



45° FIPT		
1/2"	S4E050	\$4.75
3/4"	S4E075	\$7.15
1"	S4E100	\$10.55
1 1/4"	S4E125	\$15.25
1 1/2"	60109415	\$18.85

NIPPLES



1/4" close	610151	\$3.60
1/4" x 3"	601104003	\$3.90
1/4" x 6"	SNI256	\$8.40
3/8" close	60150375C	\$4.15
3/8" x 2"	60382	\$4.33
3/8" x 2 1/2"	SNI3725	\$5.00
3/8" x 3"	60150383	\$5.05
3/8" x 4"	601503754	\$6.65
3/8" x 5"	SNI375	\$7.20
3/8" x 6"	SNI376	\$8.40
1/2" close	60150500C	\$4.25
1/2" x 1 1/2"	SNI051	\$5.00
1/2" x 2"	601105002	\$5.25
1/2" x 2 1/2"	6015150025	\$5.70
1/2" x 3"	60115003	\$5.95
1/2" x 4"	601105004	\$6.10
1/2" x 5"	60111501	\$9.15
1/2" x 6"	60115006	\$9.80
3/4" x close	60110750C	\$4.55
3/4" x 2"	601107502	\$5.05
3/4" x 3"	601107530C	\$4.35
3/4" x 4"	711005	\$6.80
3/4" x 5"	711015	\$7.00
3/4" x 6"	711003	\$8.90
3/4" x 8"	SNI758	\$17.80
1" close	60151000C	\$4.80
1" x 2"	601002	\$5.90
1" x 3"	60111003	\$7.15
1" x 4"	711004	\$8.40
1" x 5"	601110500	\$9.05
1" x 6"	601110006	\$11.95
1" x 8"	60118	\$23.80
1 1/4" close	60111250C	\$8.20
1 1/4" x 2 1/2"	601112525	\$11.95
1 1/4" x 3"	601112503	\$12.90
1 1/4" x 4"	711006	\$13.80
1 1/4" x 5"	SNI125	\$16.80
1 1/4" x 6"	711017	\$18.00
1 1/2" close	60111500C	\$8.40
1 1/2" x 2 1/2"	6011150025	\$12.25
1 1/2" x 3"	60111503	\$13.55
1 1/2" x 4"	711009	\$14.30
1 1/2" x 5"	SNI155	\$17.10
1 1/2" x 6"	601115006	\$18.90
1 1/2" x 8"	SNI158	\$29.30
2" close	60152000C	\$11.10
2" x 3"	SNI203	\$18.00
2" x 6"	601120006	\$20.90

Other lengths available:
12"-24"-48"-72"-96". Contact us.

REDUCERS



FIPT X FIPT		
1/4" x 3/8"	SC2537	\$7.20
1/2" x 1/4"	SC5025	\$8.40
1/2" x 3/8"	SC5037	\$8.40
3/4" x 1/4"	SC7525	\$9.60
3/4" x 3/8"	SC7537	\$10.20
3/4" x 1/2"	SC7550	\$10.60
1" x 1/4"	SC1025	\$16.80
1" x 3/8"	SC1037	\$16.80
1" x 1/2"	SC1050	\$16.80
1" x 3/4"	SC1075	\$16.80
1 1/4" x 1/2"	SC1250	\$25.25
1 1/4" x 3/4"	SC1275	\$25.25
1 1/4" x 1"	SC1210	\$25.25
1 1/2" x 1/2"	SC1550	\$28.90
1 1/2" x 3/4"	SC1575	\$28.90
1 1/2" x 1"	SC1510	\$28.90
1 1/2" x 1 1/4"	SC1512	\$28.90
2" x 1"	SC2010	\$36.70
2" x 1 1/2"	SC2015	\$36.70



MIPT X FIPT		
1/4" x 3/8"	711014	\$3.60
1/2" x 1/4"	715025	\$3.65
1/2" x 3/8"	705038	\$3.70
3/4" x 1/4"	713414	\$4.90
3/4" x 3/8"	713438	\$4.95
3/4" x 1/2"	713412	\$5.00
1" x 1/4"	714014	\$8.75
1" x 3/8"	SB1037	\$8.90
1" x 1/2"	711012	\$9.00
1" x 3/4"	711034	\$9.60
1 1/4" x 3/8"	SB1237	\$9.50
1 1/4" x 1/2"	665551	\$10.20
1 1/4" x 3/4"	714075	\$10.70
1 1/4" x 1"	714100	\$10.85
1 1/2" x 1/2"	712050	\$13.15
1 1/2" x 3/4"	712034	\$14.00
1 1/2" x 1"	711210	\$15.00
1 1/2" x 1 1/4"	712114	\$15.50
2" x 1/2"	SB2050	\$23.45
2" x 3/4"	711013	\$23.65
2" x 1"	711020	\$23.90
2" x 1 1/4"	711225	\$24.10
2" x 1 1/2"	712015	\$24.30

DRAW-OFF ELBOWS



MIPT		TUBE	
1/2"	3/4"	SDE050	\$36.50
3/4"	1"	SDE075	\$38.60
1"	1"	6788991D2	\$40.75
1 1/4"	1 1/2"	SDE125	\$42.90
1 1/2"	2"	SDE150	\$45.05

QUICK COUPLINGS / POLYETHYLENE



PART A		
1/2"	6620102	\$3.75
3/4"	6620107A	\$3.90
1"	6620111	\$4.80
1 1/4"	6620109A	\$4.95
1 1/2"	6620110A	\$5.05
2"	66202A	\$6.30
3"	6620302	\$14.85



PART B		
1/2"	6620104	\$8.70
3/4"	6620107B	\$9.05
1"	6620118	\$11.30
1 1/4"	6620129	\$13.20
1 1/2"	6620137	\$13.30
2"	66202B	\$15.40
3"	6620103	\$28.65



PART C		
1/2"	6620140	\$10.05
3/4"	6620107C	\$10.10
1"	6620108	\$10.15
1 1/4"	6620109C	\$14.60
1 1/2"	6620110	\$15.25
2"	66202C	\$16.65
3"	6620305	\$27.65



PART D		
1/2"	6620106	\$10.05
3/4"	6620107D	\$10.60
1"	6620119	\$11.05
1 1/4"	6620120	\$12.45
1 1/2"	6620133	\$12.65
2"	66202D	\$15.40
3"	6620300	\$30.55



T FIPT X FIPT		
2"	63250	\$12.90
3"	63245	\$44.35



ELBOWS FIPT X FIPT		
2"	63252	\$10.35
3"	63244	\$44.35



COUPLINGS FIPT X FIPT		
2"	63249	\$15.05
3"	63246	\$23.60



PART E		
1/2"	6620141	\$4.70
3/4"	6620112	\$4.90
1"	6620113	\$5.25
1 1/4"	6620114	\$5.35
1 1/2"	6620115	\$5.55
2"	66202E	\$7.15
3"	6620309	\$23.00



PART F		
1/2"	6620105	\$4.90
3/4"	6620121	\$5.05
1"	6620122	\$5.30
1 1/4"	6620127	\$6.00
1 1/2"	6620128	\$6.10
2"	6620160	\$6.95
3"	6620306	\$22.85



PART DP		
3/4"	6620130	\$4.30
1"	6620123	\$4.60
1 1/2"	6620131	\$4.90
2"	6620138	\$7.00
3"	6620311	\$15.40



PART DC		
3/4"	6620134	\$10.05
1"	6620125	\$10.75
1 1/2"	6620135	\$12.90
2"	6620139	\$16.80
3"	6620144	\$27.65



GASKETS		
3/4"	6607901	\$1.45
1"	6607902	\$1.50
1 1/4" et 1 1/2"	6607903	\$1.55
2"	6607904	\$2.00
3"	6607905	\$3.00



REDUCERS MIPT X FIPT		
3" X 2"	63251	\$15.10



NIPPLES MIPT X MIPT		
2"	63248	\$7.15
3"	63247	\$23.60



BALL VALVES		
2" FIPT	63242	\$52.50
2" MIPT	63243	\$57.55
2" 3-WAY FIPT	710156	\$112.00
3" FIPT	63253	\$109.15

FITTINGS, VALVES AND PLUMBING



A- COUPLINGS WITHOUT RESTRICTION

MIPT X INS		
3/4"	630100	\$3.95
1"	630101	\$4.05
1 1/4"	630102	\$4.95
1 1/2"	630103	\$5.15

B- ADAPTORS

INS X FIPT		
1/2"	64091	\$3.05
3/4"	64092	\$3.35
1"	64093	\$3.35
1 1/4"	64094	\$4.30
1 1/2"	64096	\$5.35
2"	63230	\$8.60

MIPT X INS		
1/2"	66195	\$0.65
3/4"	64054	\$0.83
1"	64056	\$0.85
1 1/4"	66198	\$1.40
1 1/2"	66199	\$1.45
2"	66200	\$2.75

C- REDUCING ADAPTORS

MIPT X INS		
1/2" x 3/4"	64053	\$2.05
1/2" x 1"	6605301	\$2.05
3/4" x 1/2"	64058	\$1.75
3/4" x 1"	63200	\$2.30
1" x 3/4"	66089	\$2.05
1" x 1 1/4"	63205	\$2.40
1" x 1 1/2"	63204	\$3.95
1 1/4" x 3/4"	64060	\$2.15
1 1/4" x 1"	64062	\$2.35
1 1/4" x 1 1/2"	63206	\$3.75
1 1/2" x 1"	64064	\$2.75
1 1/2" x 1 1/4"	64066	\$2.90
1 1/2" x 2"	63208	\$4.65
2" x 1 1/2"	63210	\$4.60

D- TEES

INS X INS X INS		
1/2"	66022	\$1.45
3/4"	66023	\$1.45
1"	66029	\$1.85
1 1/4"	6602801	\$2.90
1 1/2"	66030	\$3.25
2"	66033	\$6.45
1/2" x 1/2" x 3/4"	63150	\$3.80
3/4" x 3/4" x 1/2"	635002	\$2.90
3/4" x 3/4" x 1"	63152	\$3.30
1" x 1" x 1/2"	6602401	\$2.05
1" x 1" x 3/4"	66024	\$2.05
1" x 1" x 1 1/4"	66020	\$5.95
1 1/4" x 1" x 1/2"	6602001	\$3.50
1 1/4" x 1" x 3/4"	6602002	\$3.50
1 1/4" x 1" x 1"	6602003	\$3.50
1 1/4" x 1 1/4" x 1/2"	6602004	\$3.20
1 1/4" x 1 1/4" x 3/4"	66025	\$3.45
1 1/4" x 1 1/4" x 1"	66028	\$4.15
1 1/2" x 1 1/4" x 1"	66028011	\$4.45
1 1/2" x 1 1/4" x 1 1/4"	66028021	\$4.45
1 1/2" x 1 1/2" x 1/2"	6602803	\$4.30
1 1/2" x 1 1/2" x 3/4"	66026	\$4.45
1 1/2" x 1 1/2" x 1"	66027	\$4.50
1 1/2" x 1 1/2" x 1 1/4"	66021	\$4.70
2" x 1 1/2" x 1 1/2"	6602101	\$7.40
2" x 2" x 1/2"	6602102	\$6.20
2" x 2" x 3/4"	6602103	\$6.20
2" x 2" x 1"	66357	\$6.30
2" x 2" x 1 1/4"	6602105	\$6.30
2" x 2" x 1 1/2"	6602106	\$6.65

INS X INS X MIPT		
3/4" x 3/4" x 3/4"	678483	\$2.35
1" x 1" x 1"	678484	\$3.25
1 1/4" x 1 1/4" x 1 1/4"	678485	\$3.45
1 1/2" x 1 1/2" x 1 1/2"	6602804	\$4.15
2" x 2" x 2"	660331	\$5.90

INS X INS X FIPT		
3/4" x 3/4" x 1/2"	6602901	\$1.80
1" x 1" x 1/2"	6602701	\$2.35
1 1/4" x 1 1/4" x 1 1/2"	66025010	\$3.15
1 1/2" x 1 1/2" x 1 1/2"	6602601	\$4.90

E- CONNECTORS

INS X INS		
1/2"	66012	\$0.65
3/4"	66013	\$0.70
1"	66014	\$0.75
1 1/4"	66015	\$1.10
1 1/2"	66016	\$1.50
2"	63220	\$2.55

F- REDUCERS

INS X INS		
3/4" x 1/2"	66069	\$1.05
1" x 1/2"	66066	\$1.40
1" x 3/4"	66065	\$1.45
1 1/4" x 3/4"	66092	\$2.10
1 1/4" x 1"	66073	\$2.10
1 1/2" x 3/4"	66093	\$2.65
1 1/2" x 1"	63175	\$2.65
1 1/2" x 1 1/4"	66078	\$2.65
2" x 1"	63222	\$3.60
2" x 1 1/4"	63225	\$3.60
2 x 1 1/2"	66067	\$3.60

G- 90° ELBOWS

INS X INS		
1/2"	66045	\$1.20
3/4"	66046	\$1.50
1"	64068	\$1.75
1 1/4"	64070	\$2.10
1" x 3/4"	64073	\$2.45
1 1/2"	64072	\$2.15
2"	66666	\$3.15
3"	66677	\$22.60

INS X FIPT		
3/4" x 1/2"	63156	\$1.40
1" x 1/2"	64071	\$1.50

H- CAPS

INS		
1/2"	66076	\$1.05
3/4"	66043	\$1.10
1"	66059	\$1.65
1 1/4"	66060	\$2.10
1 1/2"	66061	\$2.25
2"	66062	\$4.05

FITTINGS, VALVES AND PLUMBING

VALVES



PVC

BALL VALVES (FIPT)

1/2"	63100	\$2.75
3/4"	63105	\$3.25
1"	63110	\$4.25
1 1/4"	63115	\$5.95
1 1/2"	63120	\$8.95
2"	63125	\$11.50
3"	63128	\$50.50



PVC

GATE VALVES (SLIP)

1"	66175031	\$15.20
1 1/2"	6617504	\$15.25
2"	6617506	\$21.40
3"	6617507	\$30.55



Stainless steel

VALVES (FIPT)

1/4"	6617053	\$16.30
3/8"	601438	\$18.30
1/2"	601412	\$20.35
3/4"	601475	\$26.50
1"	6013TBV21	\$34.65
1 1/4"	601414	\$50.95
1 1/2"	601415	\$71.40
2"	6013TBV22	\$91.80

CLAMPS



Brass screw

HF-10 (3/4")	66082	\$0.65
HF-16 (1")	66083	\$0.66
HF-20 (1 1/4")	660831	\$0.67
HF-24 (1 1/2")	66084	\$0.70
HF-32 (2")	6608401	\$0.75



Stainless steel screw

HS-10 (3/4")	660822	\$0.71
HS-16 (1")	6608301	\$0.72
HS-20 (1 1/4")	6608311	\$0.81
HS-24 (1 1/2")	660841	\$0.84
HS-32 (2")	60HAS32	\$1.00



Heavy duty

1"	660848	\$2.00
1 1/4"	660838	\$2.10
1 1/2"	660849	\$3.00
2"	660843	\$3.20
3"	660842	\$4.35
4"	660854	\$5.05



For flexible hose

1 1/2"	660846	\$7.95
2"	660847	\$9.35

SINGLE UNION VALVES NEW



FIPT X FIPT

1"	6618100	\$17.05
1 1/2"	6618101	\$25.95
2"	6618102	\$37.50



SLIP

1"	6618103	\$16.20
1 1/2"	6618104	\$17.95
2"	6618105	\$25.95

CHECK VALVES



Clear PVC

SLIP X SLIP

1 1/2"	6607112	\$33.60
2"	660702	\$48.45

FIPT X FIPT

1/2"	660712	\$28.50
3/4"	660734	\$31.10
1"	660701	\$32.15
1 1/4"	660714	\$33.60
1 1/2"	660715	\$36.70



Brass

SWING CHECK VALVES

1/2"	66290	\$10.15
3/4"	66709	\$12.20
1"	66710	\$17.30
1 1/4"	66712	\$27.50
1 1/2"	66704	\$35.65
2"	660704	\$56.05
2 1/2"	667101	\$96.90



White PVC

FIPT X FIPT

1/2"	660731	\$19.05
3/4"	660733	\$21.95
1"	660711	\$22.95

FITTINGS, VALVES AND PLUMBING

PVC RIGID PIPES



WHITE			
1"	6645100		\$1.20
1½"	6645006		\$1.40
2"	6645020		\$2.00
3"	6645011		\$3.55
4"	664513		\$5.05

Sold in 10' or 20' length

*Price by foot



CLEAR			
1½"	6625601040		\$4.10
2"	6625801040		\$5.50

Sold in 8' length

*Price by foot

PVC FLEXIBLE PIPES



1"	6645101	\$1.50
1½"	6645001	\$2.05
2"	6645002	\$2.85
3"	6645003	\$14.65

Not approved food grade

*Price by foot

PVC STRAPS



1"	667401	\$0.75
1¼"	667413	\$0.80
1½"	667415	\$1.20
2"	667420	\$1.80
3"	667430	\$3.80

90° ELBOWS



SP X SLIP			
1¼"	66147		\$2.70
1½"	66088152		\$2.80
2"	665530		\$5.05
3"	665499		\$11.15
4"	63214		\$19.15



MIPT X SLIP			
1"	631982		\$1.65
1½"	66088154		\$2.20
2"	665527		\$5.45



FIPT X SLIP			
1"	631981		\$1.00
1½"	66088151		\$1.80
2"	665532		\$4.60
3"	665528		\$16.85



SLIP X SLIP			
1"	63207		\$0.80
1¼"	661471		\$1.40
1½"	66088150		\$1.45
2"	665526		\$2.00
2½"	665543		\$6.75
3"	665534		\$8.10
4"	63203		\$11.70



FIPT X FIPT			
½"	63190		\$1.00
1"	63192		\$3.25
1¼"	63193		\$2.85
1½"	63194		\$3.55



22.5° ELBOWS (SLIP X SLIP)			
1½"	66088156		\$2.15
2"	665540		\$4.75
3"	665529		\$11.25



MIPT X FIPT			
½"	63196		\$1.20
¾"	63197		\$1.70
1"	63198		\$2.35
1¼"	63163		\$2.80
1½"	63166		\$3.10
2"	64086		\$6.00
3"	665512		\$17.10



45° ELBOWS (SLIP X SLIP)			
1"	63130		\$1.20
1¼"	63131		\$1.30
1½"	66088153		\$1.90
2"	665531		\$2.50

FITTINGS, VALVES AND PLUMBING

ADAPTORS



SP X FIPT			
1"	63015		\$1.65
1½"	66068154		\$2.35
2"	665585		\$2.85
3"	6606806		\$11.50



SLIP X INS			
1"	63011		\$1.35
1½"	665557		\$2.70
2"	6655461		\$5.90



FIPT X SLIP			
1"	63012		\$0.70
1½"	66068153		\$1.70
2"	665546		\$2.90
2½"	6606804		\$3.70
3"	6606803		\$4.40
4"	664094		\$11.35



MIPT X SLIP			
1" x 1"	63010		\$0.80
1½" x 1½"	66068150		\$1.45
2" x 2"	665525		\$1.60
3" x 3"	6606801		\$6.65
4" x 4"	665506		\$9.45

TEES



FIPT X FIPT X FIPT			
½"	63177		\$2.15
¾"	63182		3.40 \$
1"	63180		4.60 \$
1¼"	63178		\$5.30
1½"	63179		\$6.25
2"	63181		\$8.40



SLIP X SLIP X SLIP			
1"	63184		\$1.30
1½"	66058150		\$1.85
2"	665545		\$2.50
3"	664565		\$11.05
4"	664599		\$17.30



SLIP X SLIP X FIPT			
1"	631801		\$1.55
1½"	66058151		\$3.00
2"	665637		\$3.70

CAPS



SLIP			
1"	669734		\$0.50
1½"	630351		\$0.90
2"	668820		\$1.10
3"	66881		\$3.20
4"	66882		\$10.15



MIPT			
¼"	66053		\$0.90
½"	66052		\$0.95
¾"	6606101		\$1.00
1"	6606102		\$1.65
1¼"	6606103		\$1.80
1½"	63035		\$2.00
2"	66058		\$2.50
2½"	660585		\$4.35
3"	66884		\$6.05



FIPT			
½"	660521		\$0.75
¾"	660801		\$0.95
1"	660802		\$1.55
1¼"	660586		\$2.00
1½"	630352		\$2.55
2"	660583		\$3.00
2½"	660584		\$4.60

REDUCERS



MIPT X FIPT		
3/4" x 1/4"	660777	\$1.45
3/4" x 1/2"	63185	\$1.45
1" x 1/2"	66973	\$1.55
1 1/4" x 1/2"	63171	\$1.75
1 1/4" x 1"	63170	\$2.00
1 1/2" x 3/4"	66976	\$2.80
1 1/2" x 1"	66977	\$3.10
1 1/2" x 1 1/4"	66974	\$3.20
2" x 3/4"	669782	\$3.00
2" x 1"	669791	\$3.00
2" x 1 1/4"	66978	\$3.00
2" x 1 1/2"	66979	\$3.05



SP X FIPT		
1 1/2" x 3/4"	66078151	\$2.40
1 1/2" x 1"	66078150	\$2.40
1 1/2" x 1 1/4"	66078152	\$2.40
2" x 3/4"	66078275	\$2.95
2" x 1"	66078201	\$3.10
2" x 1 1/4"	66078153	\$3.20
2" x 1 1/2"	66078250	\$3.25
3" x 2 1/2"	660101	\$3.55
4" x 3"	6625475	\$7.40



SLIP X SLIP		
1 1/4" x 1"	66990	\$2.00
1 1/2" x 1"	669779	\$2.75
2" x 1 1/2"	669797	\$3.05
3" x 2"	669793	\$13.00



SP X SLIP		
1 1/2" x 1"	669783	\$1.45
1 1/2" x 1 1/4"	660481	\$1.45
2" x 3/4"	669787	\$2.20
2" x 1 1/2"	662545	\$2.50
2 1/2" x 1 1/2"	669795	\$3.40
2 1/2" x 2"	669794	\$3.40
3" x 1 1/2"	669786	\$3.40
3" x 2"	679799	\$3.50
3" x 2 1/2"	669796	\$5.20
4" x 2"	669788	\$6.95
4" x 3"	669778	\$7.20



MIPT X SLIP		
1 1/4" x 1 1/2"	66068151	\$2.35
2" x 1 1/2"	66068152	\$3.30
2 1/2" x 3"	6606802	\$6.70

CONNECTORS



SLIP X SLIP		
1"	66452	\$0.65
1 1/2"	66098150	\$0.90
2"	665535	\$1.25
3"	668831	\$4.30
4"	668835	\$7.10

QUICK CONNECTORS



SLIP X SLIP		
1"	66699	\$5.05
1 1/4"	667003	\$11.40
1 1/2"	66700	\$15.30
2"	66701	\$17.95
3"	66702	\$32.65
4"	667044	\$50.50



FIPT X FIPT		
1"	66698	\$8.65
1 1/4"	667004	\$13.25
1 1/2"	6670012	\$16.85
2"	667012	\$18.35

ADHESIVES AND TEFLON



A	FusionPro tape, 2,5 cm x 3 m	661300	\$10.75
B	PVC glue, 118 ml	667055	\$4.90
B	PVC glue, 473 ml	667056	\$11.95
C	Teflon, 1/2" x 40' (10 m)	64100	\$0.75
D	Pink Teflon, 1/2" x 45' (10 m)	64105	\$3.99
	<small>Pink Teflon, 1/2" x 45' (10 m) Pink Teflon is designed for plumbing, it's more resistant than white Teflon.</small>		
E	Grey Teflon, 1/2" x 260'	64106	\$3.99
	<small>Grey Teflon is designed for stainless steel fittings</small>		

FITTINGS, VALVES AND PLUMBING

OTHER



CROSSES (SLIP)

1"	6608152	\$4.85
1½"	6608153	\$7.55
2"	6608154	\$9.30
3"	6608155	\$13.75



Y (SLIP)

1"	6613149	\$4.10
1½"	6613150	\$7.90
2"	6613152	\$17.10
3"	661330	\$29.50

RUBBER COUPLINGS AND CLAMPS



COUPLINGS

1¼"	66094	\$6.35
1½"	669050	\$6.65
2"	669051	\$8.10
3"	669058	\$10.70
4"	669060	\$13.20



REDUCERS

1½" x 1¼"	66099	\$6.65
2" x 1½"	66098	\$8.10
4" x 2"	669054	\$16.85
3" x 4"	669059	\$17.30

HOSES



CLEAR FLEXIBLE VACUUM

¾"	66450512	\$2.35/ft
1"	6645051	\$3.35/ft
1¼"	664504	\$3.55/ft
1½"	664505	\$5.10/ft
2"	6614922	\$5.95/ft
3"	664503	\$11.15/ft



1/8" CLEAR THIN WALL

¾"	6600300	\$1.35/ft
7/8"	660078 *	\$2.40/ft
1"	66004001	\$1.95/ft
1-1/8"	660112 *	\$2.00/ft
1¼"	664507	\$2.85/ft

Not recommended for vacuum (maximum 30 PSI)
* Use on CDL reverse osmosis



FLEXIBLE HIGH PRESSURE

¾"	66243	\$1.55/ft
1"	6600400	\$2.50/ft
1¼"	6600500	\$3.95/ft
1½"	66006099200	\$5.75/ft
2"	661491	\$6.95/ft

100 PSI and more (pressure)
For pressure pumps



1/4" CLEAR THICK WALL

¾"	660030012001	\$3.65/ft
1"	660040012001	\$4.25/ft
1¼"	660050992001	\$5.45/ft
1½"	660060992001	\$8.10/ft
2"	66149	\$8.40/ft

Can be used with vacuum (50 to 60 PSI maximum)
Maximum 24 inches of mercury.

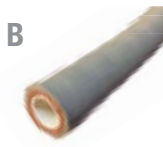

FOR FILTER PRESSES

A	Clear 5/8"	6600210	\$2.45/ft
A	Clear 1"	6600110	\$4.85/ft
B	5/8" High temperature high pressure	66285	\$7.55/ft

Use between the pump and the plates.



The reference in the maple syrup industry

for two decades, because it offers many competitive advantages.

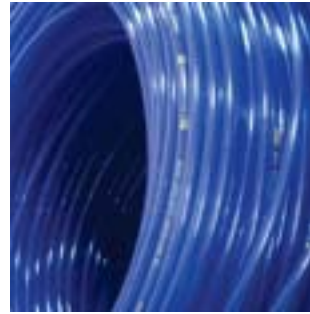

Cold sugarbush, facing north

The 4-SEASONS SHADOW tubing is now darker to help lines thaw faster!

5/16" 4-SEASONS TUBING

WARRANTY

5 years	Blue	6600127205	500'
10 years	Blue	6600130805	500'
15 years	Blue	6600127209	500'
10 years	Flash green	6600138110	500'
10 years	Shadow grey	6600144010	500'
15 years	Shadow grey	6600142415	500'

PRECUT DROPS

WARRANTY

10 years	Clear	6600100030	30"
10 years	Clear	6600100036	36"
10 years	Clear	6600100040	40"



Other colors and lengths available upon request.
Minimum quantity: 10 000 units

- ADVANTAGES**
- > Unequaled translucency;
 - > Longest life expectancy;
 - > Malleable in all temperatures;
 - > Resists falling trees, branches and freezing rain;
 - > No leakage on CDL fittings;
 - > Permanent marking;
 - > Best warranty on the market.

Our precut drops will save you work in the preparation of your drops.

Completely clear for an optimal visibility at a good price.

Again, the unique plastic recipe with UV stabilisers and an established reputation is offered to optimize yield and durability.

Available in 30, 36 and 40 inch length, and packaged in bundles of 100 units.

5/16" TUBING



5/16" CDL TUBING

WARRANTY		BLUE		
10 years	5/16" CDL Semi-rigid	451610021	500'	
10 years	5/16" CDL 50	451610031	500'	
5 years	5/16" CDL Rigid	451605011	500'	
10 years	5/16" CDL Flex	451610001	500'	
15 years	5/16" CDL Flex	451615001	500'	
WARRANTY		GREEN		
10 years	5/16" CDL Semi-rigid	451610025	500'	
5 years	5/16" CDL rigid	451605015	500'	
10 years	5/16" CDL Flex	451610004	500'	

ADVANTAGES OF SEMI-RIGID

- > Ideal for straight and long laterals.
- > Good translucency.
- > Same properties as the CDL Flex.

ADVANTAGES OF FLEX

- > Flexible at all temperatures.
- > Resists falling trees.
- > No leakage.
- > Permanent marking on tubing.

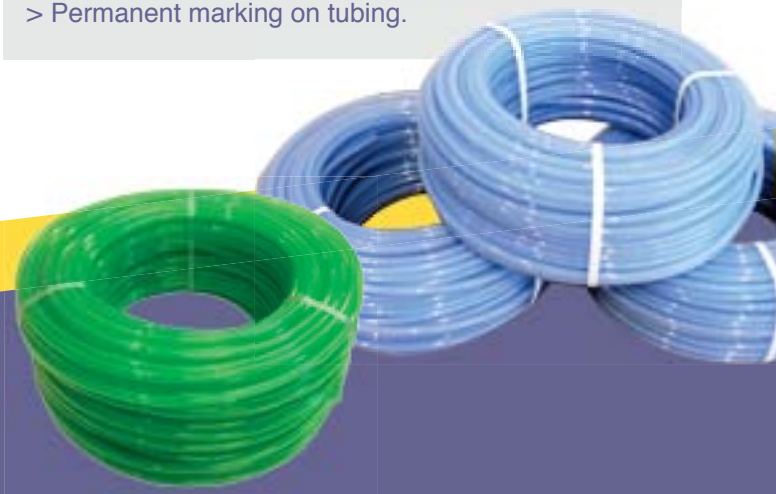

**In-store drop
assembly service.**
Ask your CDL representative.

CDL HIGH DENSITY MAINLINE / 100 PSI

WARRANTY		BLACK	BLUE	GREEN	
10 years	¾"	403410069	403410061	403410065	500'
10 years	¾"	403410269	403410261	403410265	1 000'
10 years	¾"	403410169	403410161	-	Spool 2 500'
10 years	1"	410010069	410010061	410010065	500'
10 years	1"	410010269	410010261	410010265	1 000'
10 years	1"	410010169	410010161	-	Spool 1 500'
10 years	1¼"	411410069	411410061	411410065	500'
10 years	1½"	411210069	411210061	411210065	500'

ADVANTAGES

- > Superior quality high density resin.
- > More rigid than the low density.
- > Light tubing.

CDL LOW DENSITY MAINLINE / 100 PSI

The low density tubing is thicker and more flexible.

WARRANTY		BLACK	BLUE	
10 years	½"	401210049	-	500'
10 years	¾"	403410039	403410051	500'
10 years	¾"	403410139	403410151	Spool 2 500'
10 years	1"	410010039	410010051	500'
10 years	1"	410010139	410010151	Spool 1 500'
10 years	1¼"	411410039	411410051	500'
10 years	1¼"	411410139	411410151	Spool 1 000'
10 years	1½"	411210039	411210051	500'
10 years	1½"	411210139	411210151	Spool 900'

ADVANTAGES

- > Thick wall.
- > More flexible.
- > Remains flexible even in cold weather.



**Available pre-tied,
in some region.**

Ask your sales representative.

MAINLINE

AERIAL/IN-GROUND HDPE TUBING

VERSAPIPE™ FUSION

- > Fused joints are as strong as the tubing itself
- > More durable and flexible than PVC
- > Available on 2500 feet steel TITANMC spools
- > Food grade and BPA-Free
- > 145 PSI



TITAN Spool

	BLACK	BLUE	GREEN	
1"	670020990500	670022720500	-	500'
1"	670020991500	670022721500	-	Spool 1 500'
1¼"	670030990500	670032720500	-	500'
1¼"	670030991000	670032721000	-	1 000'
1½"	661222920500	661222720500	-	500'
1½"	661222922500	661222722500	-	Spool 2 500'
2"	66230292	66230272	66230375	500'
2"	662302922500	662302722500	662303752500	Spool 2 500'
3"	66334292	66334272	-	Rod 50'
3"	663340990500	663342720500	-	500'
4"	663440990050	663432720050	-	Spool de 50'



BURIED



END TO END FUSION



PORTABLE PROPANE IRON

WIRELESS MAINLINE TUBING

RAPITUBEV2™

TRANSLUSCENT BLUE		
¾"	6600727250RT	500'
¾"	6600727227RT	Spool 3 500'
1"	6600827250RT	500'
1"	6600827227RT	Spool 3 000'
RAPIFIX TENSION STRAPPING		
Black	66300099	200'

Prices available upon request



Flexible and so simple!

100 PSI
3x quicker to install
10x easier to use
20x more satisfying

The complete installation guide for the RapiTubeV2MC is available on our website www.rapi-tube.com or by visiting YouTube.

Good viewing!

ELECTROFUSION



ELECTRO SADDLES



1¼" x 1"	66130125X100
1½" x 1"	66130115X100
2" x 1"	6613012X100
2" x 1¼"	6613012X12500
2" x 1½"	6613012X150
3" x 1"	6613013X100
3" x 1¼"	6613013X12500
3" x 1½"	6613013X1500
3" x 2"	6613013X200

ELECTRO T

NEW



1" x 1" x 1"	6613041X1X100
1¼" x 1¼" x 1¼"	661301125
1½" x 1½" x 1½"	661301150
2" x 2" x 2"	661301200
3" x 3" x 3"	6613043X3X300

ELECTRO REDUCERS



1" x ¾"	6613021X075
1½" x 1"	66130215X100
1½" x ¼"	66130215X12500
2" x 1"	6613022X100
2" x 1½"	6613022X1500
2" x 1¼"	6613022X12500
3" x 2"	6613023X200

ELECTRO COUPLINGS



1"	661303100
1¼"	66130312500
1½"	6613031500
2"	661303200
3"	661303300

A LEAK FREE solution.
FUSION system for
 aerial or buried tubing

- > Ultra quick installation of connectors.
- > Installation of connectors without cutting the tubing.

PURCHASE
 or
LEASE



Ask your CDL sales representative about purchasing or leasing a welder.



ELECTROFUSION

WIRES AND ACCESSORIES









WIRES AND ACCESSORIES			
	GALVANIZED		
	#9 50 lb	66040	\$69.95
	#12 50 lb	66049	\$69.95
	#14 50 lb	66051	\$69.95
	HIGH TENSION		
	#12,5 50 lb	ETBRO12.5HT	\$85.95
	Carbon #9 50 lb	66054	\$73.25
	Hydro aluminum # 10 50 lb	660301	Price upon request
	LINCHING WIRE		
	Stainless steel 1 200'	660660	\$37.95
	Medium gripple 10-14 GA	665503	\$1.85/un.
	Large gripple 7,5-10 GA	665505	\$3.95/un.
	Repair wire # 9	662000	\$3.65/paire
	Repair wire # 10	662001	\$3.65/paire
	Repair wire 3/16"	662003	\$3.95/pair
	Repair wire for 1/4" cable	662004	\$4.50/pair
	Steel cable 1/8"	60042	\$0.15/ft
	Steel cable 3/16"	60045	\$0.18/ft
	Steel cable 1/4"	60043	\$0.35/ft
	1/8" Cable clamp	66038	\$0.61
	3/16" Cable clamp	66036	\$0.57
	3/8" hook tensioning screw	667073	\$4.99
	Sainless steel ratchet	ETMRAT01	\$4.99
	12,5 GA wire link	WL12LINK	\$4.99
	Rachet handle for wire	ETMRAT02	\$9.95

WIRE TIES			
	5" 1000/pkg for 3/4" tubing	660851	\$10.95
	6" 1000/pkg for 1" tubing	660861	\$12.95
	7" 1000/pkg for 1 1/4" tubing	660871	\$13.95
	8" 1000/pkg for 1 1/2" tubing	660881	\$15.95
	10" 1000/pkg for 2" tubing	660811	\$18.25
	12" 2500/pkg	66400112	\$52.00
	14" 2500/pkg for 3" tubing	66096	\$56.95
	HEAVY DUTY NEW		
	5" 1000/pkg for 3/4" tubing	66085116	\$14.60
	6" 1000/pkg for 1" tubing	66086116	\$16.10
	7" 1000/pkg for 1 1/4" tubing	66087116	\$18.15
	8" 1000/pkg for 1 1/2" tubing	66088116	\$19.60
	10" 1000/pkg for 2" tubing	660810116	\$23.20
	12" 2500/pkg	6640011216	\$55.00
	14" 2500/pkg for 3" tubing	6609616	\$72.00

Also available in 18" lenght

TENSION GRIP			
	open 3/4"	663093	\$15.00
	open 1"	663092	\$16.10
	1/2"	663094	\$13.75
	3/4"	663098	\$12.10
	1"	663099	\$15.05
	1 1/4"	663097	\$21.95
	1 1/2"	663096	\$39.95
	2"	663095	\$56.40
	3"	663089	\$105.00

WIRE TOOLS

	CDL wire gripper 1 000 kg For wires #9-10 667065	\$57.95		"Contractor" pliers for gripper installation 665504	\$135.00
	Hydro wire gripper For #9-12 wires 667069	\$70.50		Light clamp for gripper 665522	\$95.00
	Spring loaded wire gripper 667068	\$79.05		Manual wire twister 66090	\$5.95
	Crimping tool 665701	\$58.05		Automatic wire twister 66091	\$29.00

MARKING ACCESSORIES AND TOOLS













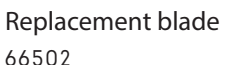

	Orange fluorescent tape 661015	\$2.25		NIKON hypsometer 550 forestry pro For slopes and distance 66064	\$605.00		
	Pink fluorescent tape 661016	\$2.25			Optical level 66068	\$79.95	
	Yellow fluorescent tape 661018	\$2.25				Topofil dispenser 661145	\$235.00
	Blue fluorescent tape 661017	\$2.25				Thread for dispenser 9 900' 661146	\$7.25
	Green spray paint 661141	\$8.00		Wooden handle for spray cans 66175	\$13.95		
	Yellow spray paint 661142	\$8.00					
	Orange spray paint 661144	\$8.00					
	Red spray paint 661147	\$8.00					
	Blue spray paint 661149	\$8.00					

PREMIUM
QUALITY TAPE
4-SEASON

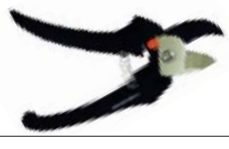

LONG LASTING

TOOLS



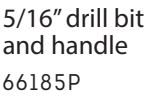
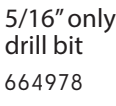

PLIERS FOR SPOUTS AND TUBING

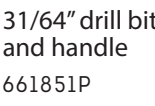
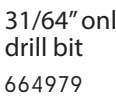
	3/16" Compact insertion pliers Anti-ice jaws 73067	\$99.95		Stripping pliers Modified blade to facilitate cutting without breaking 73063	\$99.95
	Compact insertion pliers Anti-ice jaws 73062	\$99.95		Replacement blade 66502	\$22.85
	Stripping pliers 5 functions 664963	\$122.00		Repair pliers for 5/16" tubing ETPTR03C	\$79.95
	Compact insertion pliers with knife and tubing stretcher 66559	\$120.75		Repair pliers for 3/16" tubing ETPTR0316C	\$79.95
	Compact insertion pliers 66558	\$109.10		1 1/4" & 1 1/2" tubing cutters 63001	\$19.95
	Replacement blade for pliers 66500	\$35.65		2" tubing cutters 63005	\$28.95
	4W compact pliers with blade 66557	\$112.15		5/16" nut driver 660911	\$8.95
				FISKAR pliers 63FISK	\$14.95
				NEW 3/16" tension hooks 669103	\$12.50
				5/16" tension hooks 669104	\$12.50

PUNCHES

	5/16" Self-adjusting 73060	\$99.95		5/16" drill bit and handle 66185P	\$45.95		5/16" only drill bit 664978	\$13.75
	31/64" Self-adjusting 73059	\$99.95		31/64" drill bit and handle 661851P	\$49.95		31/64" only drill bit 664979	\$25.95

TOOLS FOR TUBING

	24" Drop line cutter 668085	\$499.00
	30" Drop line cutter 668086	\$499.00
	36" Drop line cutter 668089	\$599.00
	40" Drop line cutter 668088	\$650.00
	48" Drop line cutter 668048	\$750.00
	Repair pliers with pivot 66501	\$106.75
	5/16" Drop line pliers 66496	\$250.00
	3/16" Drop line pliers 66497	250.00 \$
	NEW 5/16" Condensed fitting pliers <small>New lighter and compact model</small> 73080	\$265.00
	NEW 3/16" Condensed fitting pliers <small>New lighter and compact model</small> 73081	\$265.00
	Automatic Deluxe drop line pliers 662153	\$288.50

REELS

	Horizontal for 5/16" tubing 660411	\$88.50
	Vertical for 5/16" tubing 660410	\$130.00
	For wire 66041	\$170.00
		
Galvanized mainline reel on wheels	660416	Price upon request
Toolbox (optional)	660417	Price upon request
Wire reel (optional)	660418	Price upon request

MAINLINE DOUBLE FORK PLIERS





		
1" and 3/4"	662191	\$225.90
1 1/2" and 1"	66219	\$274.95
3/4" to 2" Kit	662196	\$365.90
1 1/4" and 1"	662194	\$225.90
1 1/2" and 1 1/4"	662195	\$233.15
2" and 1 1/2"	662192	\$239.75
3"	662193	Price upon request

TOOLS

TAPPING ACCESSORIES

	CDL Tapping hammer Aluminum handle 73064	\$23.50		12" Wooden tapping hammer 729254045	\$5.95
	2 face tapping hammer Aluminum handle 68041	\$22.25		Tapping mallet with wooden handle 64085	\$34.95
	Tapping hammer with blade Aluminum handle 68042	\$30.25		1L bottle + vaporizer 663440	\$4.25
				1L bottle 66344	\$2.25
				Vaporizer 663441	\$3.25

DRILL BIT

	7/16" titanium bit	66251	\$22.35
	19/64" long bit	662542	\$19.50
	5/16" long bit	662540	\$19.50
	5/16" Bolduc bit	662543	\$24.50
	19/64" Bolduc bit	662544	\$24.50

SHORT HIGH PERFORMANCE DRILL BITS

	5/16" bit	662516	\$19.50
	19/64" bit	66259	\$19.50
	17/64" bit	66252	\$19.50
	9/32" bit	66262	\$19.50
	1/4" bit	662414	\$19.50

POWER DRILLS AND ACCESSORIES

CDL
exclusivity

	20V Dewalt drill 663920	price upon request
	20V Dewalt battery 663925	price upon request
	12V-20V Dewalt charger 663921	price upon request



Catalog promotion on complete kit.

Bonus carrying bag
663920K price upon request

ADVANTAGES

- > the best tapping drill in the world.
- > Specially designed for the maple syrup industry.

HEAD AT 90° WITHOUT BRUSH 2000 RPM LONG LASTING 5A LITHIUM BATTERY

This **high quality and high precision** tool has been designed by professionals to correct and reduce tapping problems caused by conventional drills.

Using this tool ensures **high quality tap** holes and **prevents leaking spouts**.



**Precision.
Performance.
Productivity.
Profit.**

Precision tapper kit <small>*Tapping bit adaptor not included Includes: 1 drill, 2 batteries, 1 carrying bag et 1 precision template.</small> 663970	\$725.00	Adaptor for 1/4" bit 6639714	\$78.95
Precision tapper adaptor <small>(precision template) *Installation included on your drill</small> 663971	\$395.00	Adaptor for 17/64" bit 6639764	\$78.95
		Adaptor for 19/64" bit 6639964	\$78.95
		Adaptor for 5/16" bit 6639716	\$78.95

WHY CHOOSE A PRECISION TAPPER?

- > Repetitiveness.
- > Prevents oscillation.
- > Depth control.
- > Fail-safe mechanism.
- > Bit protection.
- > Angle adjustment.

ADVANTAGES

- > Reduces leakage due to perfect tap holes.
- > Decreases the introduction of bacteria into the tap hole.
- > Reduces the chances of having to drill a 2nd time.
- > Reduces costs from leakage management.
- > General productivity increase: by improving the tapping quality you improve production.



COMMON PROBLEMS LINKED TO USING CONVENTIONAL DRILLS

- > Inconsistency.
- > Oval holes.
- > Holes too deep.
- > Operator errors.
- > Damaged bits.

RESULTS

- > Vacuum loss.
- > Decrease in production.
- > Increased labor costs.
- > Poor tree health.

**Lighter
Better bit visibility
Installs and fits
most drill models
No more racing
(possibility of drilling up to 2 3/4")**

Watch the video on www.cdllinc.ca/videos

TOOLS

OTHER



Work apron
66932 \$78.50



NEW
CDL Work apron
66934 \$135.00



Junior snowshoes
with bindings
6661810 \$89.00



Junior bindings
6660141 \$45.50

Senior snowshoes
with bindings
6661809 \$99.00

Senior bindings
6660142 \$48.50

CAPTEUR DE FUITES

Finds vacuum leaks:

- > Vacuum pumps
- > Reverse Osmosis
- > Tubing and valves
- > Cracks
- > Fitting joints
- > Extractors

Identification of the leak using a LED bar graphic combined with a sound signal.



Revolutionary tool specifically designed for pumping stations and vacuum centrals.

Finds leaks impossible to detect with the human ear, regardless of back ground noise, the temperature or the season.



SUPER SPECIAL

Leak finder kit 681010* \$295.00

*Includes: 1 leak finder, 1 pair of insulation and transfer earphones, 1 9V battery, 1 retractable neck support, 1 user manual, and 1 protection/carrying case.

Earphones 681011 18.95 \$

SPOUT REMOVERS



A Steel spout remover 66077 \$10.95

Aluminum spout remover, Small | 15" 68015 \$27.50

Aluminum spout remover, Medium | 22,5" 68020 \$28.50



B Aluminum spout remover, Long | 30" 68030 \$32.00

Aluminum spout remover, X-Long | 40" 68040 \$36.75

BRUSHES FOR BUCKETS AND SPOUTS



For 1,5-gallon bucket
72940020 \$69.50

For 2-gallon bucket
72940031 \$69.50



Without eyelet

For 7/16" interior spout
72940041 \$3.05



With sleeve

For 7/16" interior spout
663562 \$4.10



For 7/16" - 19/64" spout
663563 \$4.10

TUBE CLEANING SPONGES



¾" - 1" 661432 \$3.60

1½" - 1¼" 661433 \$3.75

2" 661435 \$5.50

3" 661436 \$5.75

TRANSFER SIPHON



Transfer siphon for
isopropyl alcohol barrel \$24.95
663330

ADVANTAGES

- > Allows isopropyl alcohol transfer from barrel to back pack container.
- > Very simple, very easy to use, very safe.
- > May be used to transfer other liquids such as water or fuel.

BACKPACK CLEANING KIT



6 litres container

Backpack cleaning kit
with harness and dozer \$165.00
661616

Backpack cleaning kit
with harness,
without dozer \$110.00
661612

More compact, lighter, more comfortable and specially designed for maple sugaring.

Specially developed by CDL for work under vacuum.



Dozer gun only,
10 to 20 ml \$55.00
661698

Harness only \$65.99
661691



Replacement tube kit
for CDL dozer \$6.50
661692



Three-piece kit
for dispenser spout \$9.95
661693

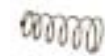

Spring for CDL dozer \$1.00
661694



ScREW cap for CDL dozer \$3.95
661689

CLEANING TOOL



NEW
CDL flow stopper pliers \$42.50
73068

MONITORING SYSTEM

Take control of your business

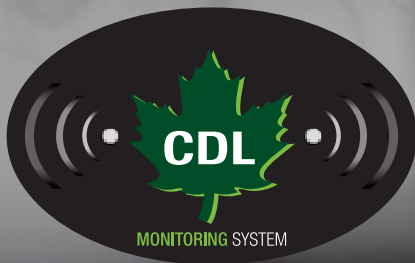

**Hundreds of
satisfied clients.**

**The best technology
on the market.**

**15,000 sensors
installed in the market.**

100% Control.

Return on investment in 1.5 year.

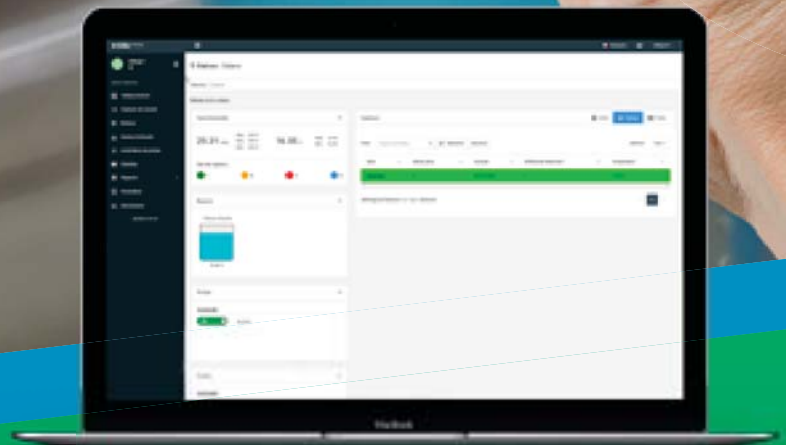
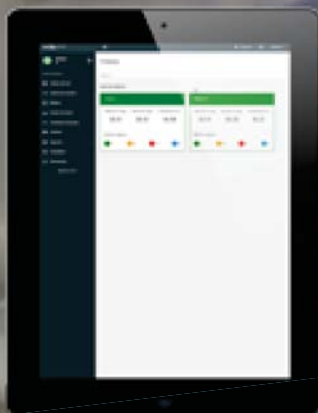

CDL's remote monitoring system, our promise:

Simple and Efficient

Because our technology is based on over 25 years of expertise in the manufacturing of sugaring equipment. The CDL monitoring system is simple to install and use...

Absolute control

Because when you have control, you have peace of mind. Save time and money with remote management via your phone, tablet and/or computer.

CDL monitoring technology allows management, control and visualization of:

- > Leaks
- > Tank levels
- > Pumps
- > Vacuum levels
- > Camera
- > Temperature in the station and in the forest
- > Intelligent reverse osmosis

Profitability

Because during sugaring season every minute, every drop counts... Increasing productivity is the key to the profitability of your sugaring operation. The CDL monitoring system not only saves time and labor, but also allows you to get the most out of your equipment by viewing your data in real time, with the precise and quick repairs of leaks, and much more.

	Digital HD camera IP 20x 120m	20200
	Pump control (2 pumps)	SA100-M2
	Pump control (4 pumps)	SA100-M4
	Pump control (6 pumps)	SA100-M6
	Double vacuum monitoring control	SE100-V-2
	Simple vacuum monitoring control	SE100-V
	Tank level sensor	SA100-HT
	V2 Communication gateway	SG100-V2
	Control base	21070A
	Sniffer	PG100-V

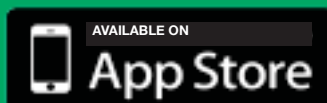

- > Unique on the market.
- > Advanced CDL technology.
- > For an unparalleled stability of the system in the forest.

The CDL antennas allow a better dispersion of the waves and an optimal capture of the signals.

EXTRACTORS WITH SUBMERSIBLE PUMP

Perfect for
HIGH VACUUM

HORIZONTAL WITH SUBMERSIBLE PUMP TANK DESIGN

The specified measurement is the distance between the base of the extractor and the center of water entry.

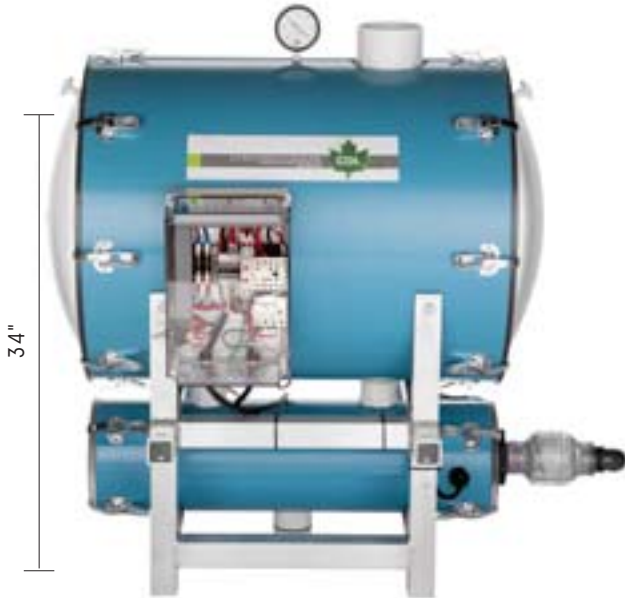

Can be installed on a tank or on the ground.

18" x 24"	2024ES	½ HP
18" x 36"	2024ES2	2 HP

Pressure gauge not included

Prices available upon request



ADVANTAGES

- > No sap-return in the 5/16" tubing.
- > High quality submersible pump.
- > Can be installed on a tank to allow drainage by gravity during shutdown periods.
- > No air in the tubing system while extracting sap.
- > Solves the sap extraction problems caused by pumping at high vacuum.
- > No float design, extremely reliable.



HORIZONTAL WITH SUBMERSIBLE PUMP

The specified measurement is the distance between the base of the extractor and the center of water entry.



18" x 48"	204820ES	½ HP
18" x 48"	204820ES2	2 HP
18" x 48"	204820ES2D	2 x 2 HP
18" x 60"	206020ES3	3 x 2 HP
18" x 60"	206020ES4	4 x 2 HP

Pressure gauge not included

Prices available upon request



ADVANTAGES

- > No sap-return in the 5/16" tubing.
- > High quality submersible pump.
- > No air in the tubing system while extracting sap.
- > Solves the sap extraction problems caused by pumping at high vacuum.
- > No float design, extremely reliable.



EXTRACTORS WITH SUBMERSIBLE PUMP

LOW HORIZONTAL

The specified measurement is the distance between the base of the extractor and the center of water entry.



22"



ADVANTAGES

- > Very low (**only 24" from the ground**)
- > No sap-return in the 5/16".
- > High quality submersible pump.
- > No air in the tubing system while extracting sap.
- > Solves the sap extraction problems caused by pumping at high vacuum.

18" x 36"	1836ES	½ HP
18" x 36"	1836ES15	1 ½ HP
18" x 48"	2048ES2	2 HP
18" x 48"	2048ES2D	2 x 2 HP

Submersible conversion kit



0.5HP 240V 1PH Submersible conversion kit	0624ES
0.5HP 240V 1PH Submersible conversion kit <i>Without probe</i>	0624ESSC
0.5HP 240V 1PH Submersible conversion kit <i>With probe</i>	0624ESAS
2.0HP 240V 1PH Conversion set	0640ES2
2.0HP 240V 1PH Submersible conversion kit <i>With probe</i>	0640ES2SC
2.0HP 240V 1PH Submersible conversion kit <i>With probe</i>	0640ES2AS

Pressure gauge not included

Prices available upon request

VERTICAL WITH SUBMERSIBLE PUMP

The specified measurement is the distance between the base of the extractor and the center of water entry.

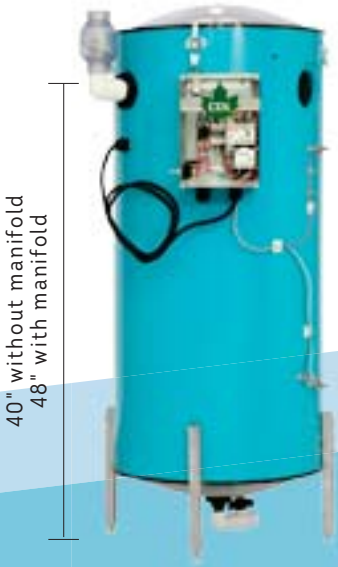

40" without manifold
48" with manifold



ADVANTAGES

- > Opening on top for easy cleaning.
- > No sap-return in the 5/16" tubing.
- > High quality submersible pump.
- > No float design, extremely reliable.
- > No air in the tubing system while extracting sap.
- > Solves the sap extraction problems caused by pumping at high vacuum.

	Without manifold	With manifold	
18" x 40"	2036ES	203608ES	½ HP
18" x 40"	2036ES2 <i>With converter</i>	203608ES2	1 ½ HP
18" x 40"	2036ESD	203608ESD	2 x ½ HP
18" x 40"	2036ES2D <i>With converter</i>	203608ES2D	2 x 1 ½ HP

Pressure gauge not included

Prices available upon request

EXTRACTORS

MECHANICAL

The specified measurement is the distance between the base of the extractor and the center of water entry.



12" x 12" 121208 750 taps



12" x 18" 121808 3 000 taps



12" x 24" 122408 4 000 taps



ADVANTAGES

- > Rapid evacuation of the sap.
- > No-maintenance mechanism.
- > Stainless steel fleet.
- > Openings at both extremities to ease cleaning.
- > Non bonded, dismountable cylinder.

18" x 24"	202608	Measure: 26"	6 000 taps	8 1/2" openings
18" x 24"	202612	Measure: 28"	12 000 taps	8 1/2" openings
18" x 36"	203612	Measure: 28"	20 000 taps	No openings

Pressure gauge not included

Prices are available upon request

ELECTRICAL

The specified measurement is the distance between the base of the extractor and the center of water entry.



12" x 18" 1000 taps
121808ESM



12" x 18" 1000 taps
121808E



12" x 24" 3000 taps
122406E



18" x 24" 202606E 4000 taps
18" x 36" 203606E 6000 taps
18" x 36" 2 outlet double float 203606ED 10000 taps

Pressure gauge not included

Prices are available upon request

MOISTURE TRAPS AND VACUUM BOOSTER TANKS

MOISTURE TRAPS

New design conceived specially for high vacuum, to capture water particles suspended in the air that are not normally retained by conventional traps. In addition, this trap offers a protection for your pumps, much better than other models on the market.



NEW
CDL 3" Moisture Trap
Mechanical/electrical
high vacuum
710607

\$995.00

A



B



C



A	CDL 2" Moisture Trap	6610508	\$185.00
B	CDL 3" Moisture Trap	710605	\$245.00
C	CDL 3" Moisture Trap Electrical shutoff	710606	\$365.00

REPAIR PARTS



Snaps D-2000
folded

662641P \$3.25

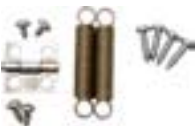

Hinge and
spring kit
for extractor

662481 \$11.95

VACUUM BOOSTER TANKS THICK WALL

HORIZONTAL



Pressure gauge included

6" x 18"	721806	\$215.00
6" x 24"	722406	\$225.00
8" x 18"	721808	\$225.00
8" x 24"	722408	\$240.00
12" x 18"	721812	\$285.00
12" x 24"	722412	\$355.00
12" x 36"	723612	\$395.00
18" x 24"	722418	\$540.00
18" x 36"	723618	\$810.00



Pressure gauge included

VERTICAL

8" x 18"	720818	\$195.00
12" x 18"	721218	\$275.00
12" x 24"	721224	\$290.00
12" x 36"	721236	\$335.00

SAP LIFTERS



Simple sap filter



Double sap filter

Triple sap filter

300 taps 73015

600 taps 73017

1 200 taps 73018

Prices are available upon request

Entrust our experts
to drill additional entries
at low cost.

VANE PUMPS L-SERIES (HIGH PERFORMANCE)

Available from 1 hp to 10 hp.

Single phase and 3 phase models available.



ADVANTAGES

- > Very compact.
- > Silent.
- > Designed to reach up to **29.9" Hg**
- > Low maintenance.
- > The best pump in the industry, CFM vs HP.

PERFORMANCE COMPARATIVE

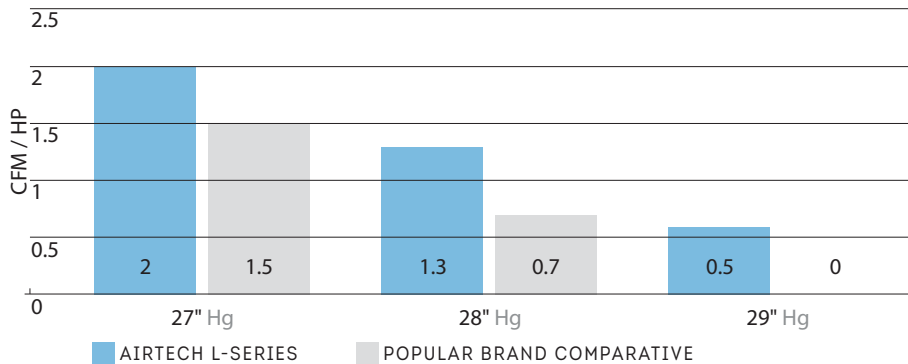

Maximum vacuum level reachable: 29.9" Hg with the L-Series Airtech pump and 28.4" Hg with other popular brand.

LIQUID RING CLOSED-COUPLED PUMPS 3AV SERIES



**Innovation
Design
Solutions**

ADVANTAGES

- > Very compact.
- > Does not require a strap or couplings.
- > Sainless steel rotor.
- > Manufactured according to the ISO-9001 standards.
- > Designed to reach up to 29" Hg.
- > Energy efficient design

ROTARY CLAW PUMPS VCX SERIES



575-volt model available upon request.

**For high vacuum
without worry.**

Contact your sales representative for more inSIZEion

CONVERSION SYSTEM FOR LIQUID RING PUMPS



High vacuum 29" Hg

For liquid ring
close-coupled
pumps

For single or
double liquid
ring pumps



High vacuum 29" Hg

Oil cooling system	1,5 HP à 5 HP	663460
Oil cooling system	7,5 HP à 20 HP	663461

ADVANTAGES

- > No more need for water or heating.
- > No onsite assembly required.
- > Compact and low maintenance.
- > Independant oil tank.
- > Adapted for low or high vacuum (15" Hg to 29" Hg).

CONVERSION SYSTEM FOR VANE PUMPS



For
DeLaval – Airablo
pump

Oil cooling system	3 HP à 5 HP	663470P
Oil cooling system	7,5 HP à 10 HP	663470

ADVANTAGES

- > Eliminates overheating of the DeLaval or Airablo pumps.
- > Very compact.
- > Allows to pump up to 25" Hg.
- > High performance radiator to keep the oil cooler.
- > Integrated thermostat optimizes performance.

DOUBLE STAGE LIQUID RING PUMPS



High vacuum 29" Hg

SiHi 3 HP, Assembled	66130
SiHi 5 HP, Assembled	66131
SiHi 7,5 HP, Assembled	66132
SiHi 10 HP, Assembled	66133

PUMPS WITH GAS MOTOR



Available models: 500 to 10 000 taps

DeLaval VP76 pump with Honda 5,5 HP	668584
-------------------------------------	--------

Can be installed with a high vacuum cooling system.

DIAPHRAGM PUMPS

A



Source : 120 volts

B



Ideal for
small
producers

A	1/2" Diaphragm pump	Up to 400 taps	669512
B	Double Diaphragm pump	Up to 700 taps	669514

ADVANTAGES

- > Pumps up to 22" Hg.
- > Works without a sap extractor.
- > Easy to use and very compact.

Prices are available upon request

VACUUM PUMP ACCESSORIES

AIR COOLED OIL RECLAIMERS



Call us, we have many used oil reclaimers in store!

With cooling fins/assembled 663450A

Prices are available upon request

ADVANTAGES

- > Improves efficiency of the pump.
- > Eliminates oil adjustments.
- > Eliminates overheating of the pump.

VACUUM REGULATOR



721212 \$112.50

OIL FOR RECLAIMERS



High vacuum oil,
18,9 L
Grade 32
663532 \$73.50

Oil recommended by 

VACUUM OIL FOR VANE PUMP



Vacuum oil, 10 L
Grade 60
Ideal for DeLaval pump
Without reclaimer
663549 \$54.95

Oil recommended by 

PHASE CONVERTERS



	CONVERTER	VARIATOR
1.5 HP	66111DA	66111DA
2 HP	66112DA	66112DA
3 HP	66113DA	66113DA
5 HP	66115DA	-
7,5 HP	66129DA	-
10 HP	66118DA	66115DA
15 HP	66015DA	66129DA
20 HP	66120DA	66118DA
30 HP	-	66015DA
40 HP	-	66120DA

Prices are available upon request

AUTOMATIC STARTERS



Temperature controlled automatic starter
669375 \$160.00



Manual adjustment kit for converter
68100 \$240.00



Vacuum Transmitter probe
GRD1632 \$245.00

OIL FOR AIRTECH PUMPS



Gear pump oil
Airtech VCX
68ATO3000 \$39.95







Synthetic oil for Airtech L-Series pumps,
1L
68ATO400001 \$19.95



Synthetic oil for Airtech L-Series pumps,
4L
68ATO400002 \$79.95

GAUGES AND PRESSURE PUMPS

GAUGES

 Vacuum	2,5" 0-30 HG 64011	\$13.35	 Glycerin pressure	2,5" 0-100 PSI Bottom outlet 66330	\$18.95
	3,5" 0-30 HG 1 % precision 64080	\$29.95		2,5" 0-100 PSI Rear outlet 663331	\$21.95
	4" 0-30 HG 3 % precision 66120	\$26.85		2,5" 0-200 PSI Bottom outlet 663339	\$18.95
 Digital vacuum	0-30 HG 64019	\$150.00	2,5" 0-200 PSI Rear outlet 663349	\$19.95	
	2,5" 0-100 PSI Bottom outlet 64010	\$9.25	2,5" 0-600 PSI Bottom outlet 663348	\$19.00	
 Pressure	2,5" 0-100 PSI Rear outlet 64016	\$16.75	2,5" 0-600 PSI Rear outlet 663337	\$22.35	
	2,5" 0-200 PSI Bottom outlet 6612003	\$12.25	2,5" 0-1 000 PSI Bottom outlet 64014	\$22.50	
			2,5" 0-1 000 PSI Rear outlet 66500210	\$23.95	

PRESSURE PUMPS (VACUUM)

GOULD PUMPS NPE SERIES

½ hp	669033	1 st
¾ hp	669003	1 st
1 hp	669000	1 st
1½ hp	669001	1 st
2 hp	669006	1 st
3 hp	669007	1 st
1 hp	669026	2 st
1½ hp	669011	2 st
2 hp	669020	2 st
3 hp	669021	2 st
1 hp	669027	3 st
1½ hp	669028	3 st
2 hp	669024	3 st
3 hp	669022	3 st

Prices are available upon request

1 st: Water inlet 1¼" and
water outlet 1" | 40 GPM

2 st: Water inlet 1½" and
water outlet 1¼" | 80 GPM

3 st: water inlet 2" and
water outlet 1½" | 120 GPM



GOULD PUMPS GB SERIES

5 GPM	665GB10	1 hp
7 GPM	667GB10	1 hp
10 GPM	6610GB10	1 hp
10 GPM	6610GB15	1½ hp
10 GPM	6610GB20	2 hp
18 GPM	6618GB10	1 hp
18 GPM	6618GB15	1½ hp
18 GPM	6618GB20	2 hp
18 GPM	6618GB30	3 hp
25 GPM	6625GB10	1 hp
25 GPM	6625GB15	1½ hp
25 GPM	6625GB20	2 hp
25 GPM	6625GB30	3 hp



E-SV Series
available upon request

Call one of our experts to determine the speed and power of your pump.

STAINLESS STEEL TANKS

ROUND BOTTOM TANKS LARGE CAPACITY

Many sizes available: 1 000 to 7 500 gallons.

ADVANTAGES

- > Strong high quality welds allow complete disinfection
- > Made of bright 304 stainless steel.



Built-in ladder at each end.

Elevated 8" for fast installation

Prices are available upon request

ROUND BOTTOM TANKS SMALL CAPACITY

Many sizes available: 50 to 1 000 gallons.



Prices are available upon request

EXTRACTOR SUPPORTS

SUPPORT KITS		
2' wide	672078	\$118.00
3' wide	672079	\$189.00
4' wide	672080	\$190.00
5' wide	672081	\$210.00
6' wide	6720821	\$230.00
7' wide	672082	\$265.00

All of our extractor supports can be adjusted to the desired depth.



Stainless steel

Personalize your tank!
Contact us for more inSIZEion.

TANKS AND ACCESSORIES

TANK LEVEL CONTROL



5' Level control
for CDL tanks
73500 \$295.00

6' Level control
for CDL tanks
73500-6 \$295.00

ADVANTAGES

- > The CDL tank level controls are made entirely of stainless steel.
- > In addition, you can very quickly and easily adjust the desired sap level where the pump will start.
- > The solidity of CDL controls prevent breakage caused by ice.

PLUGS

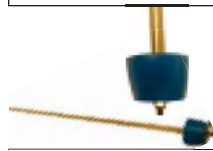

FOR TANKS			
1½"	5' Rod	678112	\$86.75
2"	5' Rod	678123	\$88.00
3"	5' Rod	67BOUCH3	\$99.50

ADAPTORS



FOR PLASTIC TANKS		
½"	RA5012	\$16.50
¾"	RA5032P	\$20.95
1"	RA5034P	\$24.65
1¼"	RA5036P	\$27.60
1½"	RA50309P	\$30.85
2"	RA5042P	\$33.05
3"	RA5454P	\$46.30



FOR STAINLESS STEEL TANKS		
1¼"	668673	\$100.00
1½"	66867	\$105.00
2"	668672	\$110.00

MIXER AND BRUX READER

Stainless steel mixer with single height adjustable blade.



Mixer for 4' and 5' wide tank 6792034

Mixer for 6' and 7' wide tank 6792567

Note: a cut in length may be required to adjust the height.

Prices are available upon request

ADVANTAGES

- > Designed to mix and homogenize the syrup in a large tank to balance the brix level.
- > Can also be used to mix a reduced syrup solution in preparation to be re-boiled.
- > Very easy to install
- > Adapts to various tank sizes



- > Allows continuous brix reading in order to homogenize the syrup before putting in barrels.
- > Reads 0.0 to 80.0 brix.
- > Automatic temperature compensation for accurate reading.
- > May be incorporated into the tubing.
- > Can read between 5°C and 100°C (41°F-212°F)
- > 24-Volt power supply
- > Requires a circulation pump

Brix reader 668421

Prices are available upon request

Adjustable stainless steel support

1/10HP Motor at 30 RPM, 115 Volts with 10' of electric cord.



Top view of support

TANKS AND ACCESSORIES

VERTICAL PLASTIC TANKS



Adaptors and level indicator included.

US GALLONS DIAMETER X HEIGHT

LARGER BASE

US GALLONS	DIAMETER X HEIGHT	MODEL	PRICE
100	28" x 43"	VER100	\$330.00
305	46" x 50"	VER305	\$660.00
550	67" x 42"	VER550	\$860.00
1 100	87" x 53"	VE1100	\$1 400.00
1 550	87" x 67"	VE1550	\$1 785.00
1 700	87" x 74"	VE1700	\$1 910.00
2 100	87" x 89"	VE2100	\$2 670.00
2 500	95" x 91"	VE2500	\$3 020.00
3 000	95" x 109"	VE3000	\$3 735.00

SMALLER BASE

US GALLONS	DIAMETER X HEIGHT	MODEL	PRICE
25	18" x 29"	SPS025	\$145.00
50	18" x 53"	SPS050	\$225.00
65	23" x 43"	SPS065	\$260.00
75	23" x 49"	SPS075	\$280.00
105	23" x 63"	SPS105	\$350.00
165	31" x 56"	SPS165	\$450.00
200	30" x 72"	SPS200	\$660.00
250	30" x 89"	SPS250	\$650.00
300	36" x 79"	SPS300	\$725.00
500	48" x 73"	SPS500	\$895.00
750	48" x 103"	SPS750	\$1 275.00
1 000	64" x 80"	SP1000	\$1 750.00
1 500	64" x 116"	SP1500	\$2 315.00

HORIZONTAL PLASTIC TANKS



Adaptors and level indicator included.
Galvanized bands not included.

US GALLONS DIAMETER X HEIGHT LID SIZE OUTLET

US GALLONS	DIAMETER X HEIGHT	LID SIZE	OUTLET	MODEL	PRICE
35	20" x 23" x 29"	5"	3/4"	HOR035	\$170.00
55	23" x 26" x 34"	5"	3/4"	HOR055	\$250.00
65	23" x 27" x 43"	5"	3/4"	HOR065	\$290.00
125	32" x 35" x 42"	8"	2"	HOR125	\$475.00
225	38" x 41" x 49"	8"	2"	HOR225	\$690.00
325	38" x 43" x 68"	16"	2"	HOR325	\$845.00
425	49" x 54" x 60"	16"	2"	HOR425	\$930.00
525	49" x 54" x 71"	16"	2"	HOR525	\$1 080.00
725	49" x 54" x 101"	16"	2"	HOR725	\$1 650.00
1 025	49" x 54" x 139"	16"	2"	HOR102	\$2 270.00
1 625	63" x 68" x 139"	16"	2"	HO1625	\$3 910.00

ELLIPTICAL

US GALLONS	DIAMETER X HEIGHT	LID SIZE	OUTLET	MODEL	PRICE
1 335	67" x 57" x 122"	16"	2"	EL1335	\$2 865.00
1 635	71" x 58" x 142"	16"	2"	EL1635	\$3 760.00
2 035	84" x 56" x 142"	16"	2"	EL2035	\$4 710.00
2 635	90" x 72" x 140"	16"	2"	EL2635	\$6 625.00
3 135	88" x 80" x 150"	16"	2"	EL3135	\$7 520.00

TANKS AND ACCESSORIES

PICKUP TRUCK TANKS



US GALLONS	DIAMETER X HEIGHT	LID SIZE	OUTLET		
210	51" x 39" x 28"	8"	2"	PUP210	\$440.00
325	62" x 49" x 33"	8"	2"	PUP325	\$645.00
425	65" x 49" x 39"	8"	2"	PUP425	\$760.00

PLASTIC TANKS VARIOUS MODELS



US GALLONS	DIAMETER X HEIGHT	LID SIZE	OUTLET		
300	29" x 49" x 62"	16"	1 1/4"	SPE300	\$935.00
400	29" x 71" x 66"	16"	1 1/4"	SPE400	\$1 220.00

This type of tank gives you the ability to pass through most standard doorways. Can be used in the basement as storage at low flow. Can not be pressurized.

SPECIAL APPLICATION

Prices are available upon request



Applicator tank

Available size: 12 US gallons.



PCO tank

Available sizes: 30 to 300 US gallons.

REPLACEMENT LIDS AND COLLARS

16" solid, non-ventilated cover	LIDP16S	\$42.50
16" ventilated, requires central cover	LIDP16	\$39.95
5" ventilated, for center of 16" cover	LIDPV5	\$12.95
12" solid, non-ventilated cover	LIDP12	\$40.50
8" solid, non-ventilated cover	LIDP08	\$28.95
5" ventilated 16" cover	LIDP05	\$21.95
8" threaded replacement collar	COL008	\$16.50
12" threaded replacement collar	COL012	\$16.75
16" threaded replacement collar	COL016	\$16.95

TANK STRAINER BASKETS



For 5" cover	STBA05	\$18.95
For 8" cover	STBA08	\$49.95
For 12" cover	STBA12	\$56.95
For 16" cover	STBA16	\$89.95

TANK HEATERS



Submersible tank heater
TANH15 \$119.95



Floating tank heater
TANH12 \$74.95

REVERSE OSMOSIS

CAPACITY OF 100 GPH - 200 GPH - 300 GPH*

500 TO 2 000 TAPS



50% reduction
in boiling time
and energy savings

ADVANTAGES

- > Economical and ultra compact.
- > Made mostly of stainless steel components.
- > All pumps are completely made of stainless steel
- > Best recirculation on the market.
- > Electrical consumption **120 volts (17 amp.), 220 volts (10 amp.).**
- > Offers a low pressure and high temperature protection.
- > Wheel system allows easy movement without effort.
- > Easy to operate.
- > No need to store in a heated room if properly drained.

* 220 volts only

CAPACITY FROM 500 GPH TO 3 600 GPH



600-gallon Osmosis

The most
efficient
on the market

Best recirculation system

ADVANTAGES

- > Entirely made of stainless steel
- > The most powerful and performant on the market today.
- > Continuous osmosis with low membrane plugging, allowing a concentration of up to 18 brix for a whole day. (Depending on the number of membranes)
- > Individual flow reading for each membrane.
- > Unique recirculation system, patented, very powerful that increases membrane life with a low maintenance submersible motor.
- > Our 5 and 7,5 hp high pressure pumps offer the highest flow on the market.

CAPACITY OF 1 900 GPH TO 5 700 GPH



The 20+ concentrators allow continuous concentration at over 20 brix without premature plugging of the membranes.

In addition, it allows for a very fast individual rinsing of the membranes to ensure an efficient washing.

100% return for the entire duration of the sugar season.

16" POST
Capacity over 2400 gallons per hour

Increase

your flow or performance by adding a 16" post to your system

Less electrical amperage required

ADVANTAGES

- > Eliminates complex plumbing.
- > Major energy savings.
- > Space saving.
- > Easy to operate.
- > Can replace more than four 8" posts.
- > Maintenance free submersible pump.
- > Superior performance with series of reduced posts.



20+ REVERSE OSMOSIS



CAPACITY OF 7 600 GPH TO 20 BRUX



ADVANTAGES

- > Designed to fit through a standard size door
- > New 10HP turbine designed by CDL allowing high flow at high pressure.



Rear view

POST CARTS

Vertical



Horizontal



New 1,5 HP turbine installed on vertical cart or horizontal for posts, preventing the clogging of the membranes at high brix.

Can easily be added to a CDL reverse osmosis previously purchased with or without cart.

ADVANTAGES

- > Facilitates post + membrane movement.
- > Allows the simultaneous moving of the posts into a room with more space to assemble the membranes.
- > Designed to fit inside a standard sized door.

ADVANTAGES

- > Compact
- > Ultra simple connections
- > Easy to operate
- > Easy access to the membranes

A Revolution in the maple syrup industry

**Quality
Reliability
Performance**

Automation by CDL

The new intelligent RO was developed to **simplify** as much as possible its operation. In addition, it allows you **full remote management** of all the operations that must be performed by the RO.

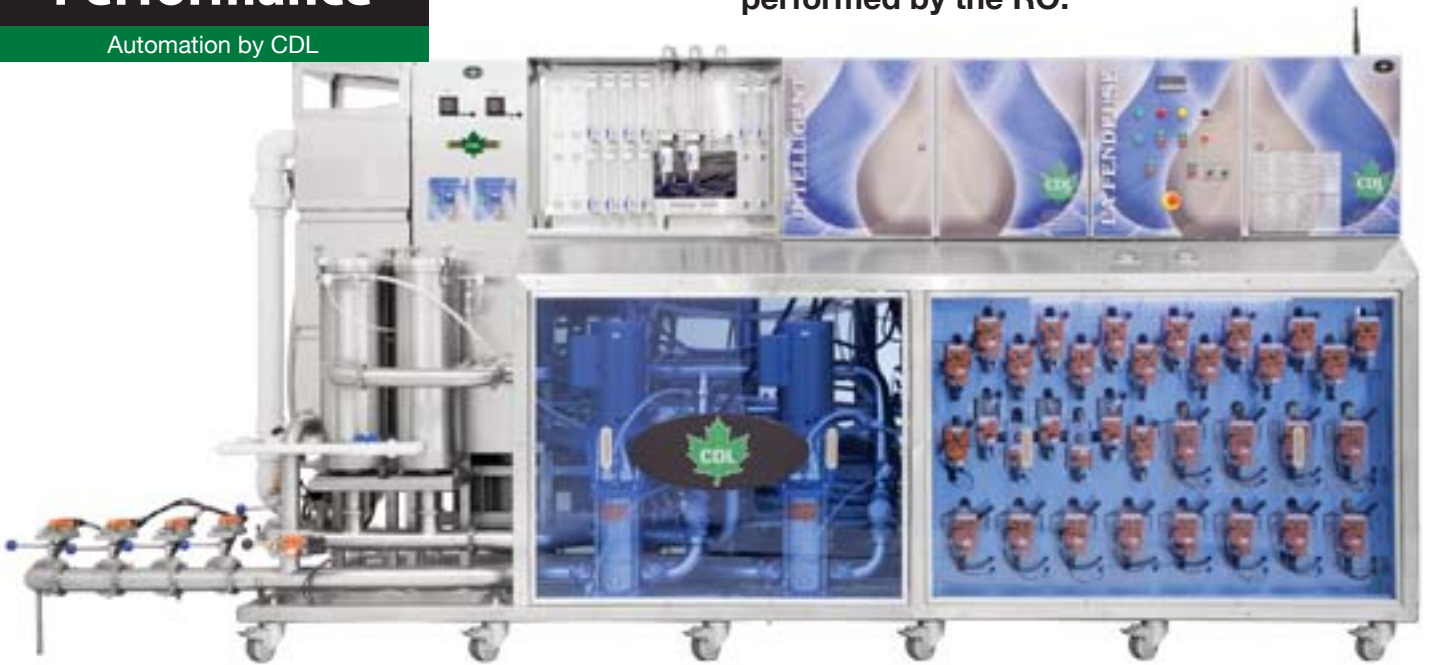

Prices are available upon request



WHAT IT CAN DO BY REMOTE CONTROL

- > Concentrate;
- > Rinse the membranes;
- > Membrane soap wash;
- > Membrane acid wash;
- > Control sap or permeate feed;
- > Continuous brix control.

Simple programming
allow you to **safely**
operate the equipment during
your rest hours,
work hours or when away
from the sugar house.

What could be better?



CDL's intelligent RO machine can be supervised and operated by the CDL monitoring system.

30+ REVERSE OSMOSIS

This new CDL concentrator series allows you to increase the brix of your concentrate to over 30 efficiently.

Saves time and energy costs

NEW

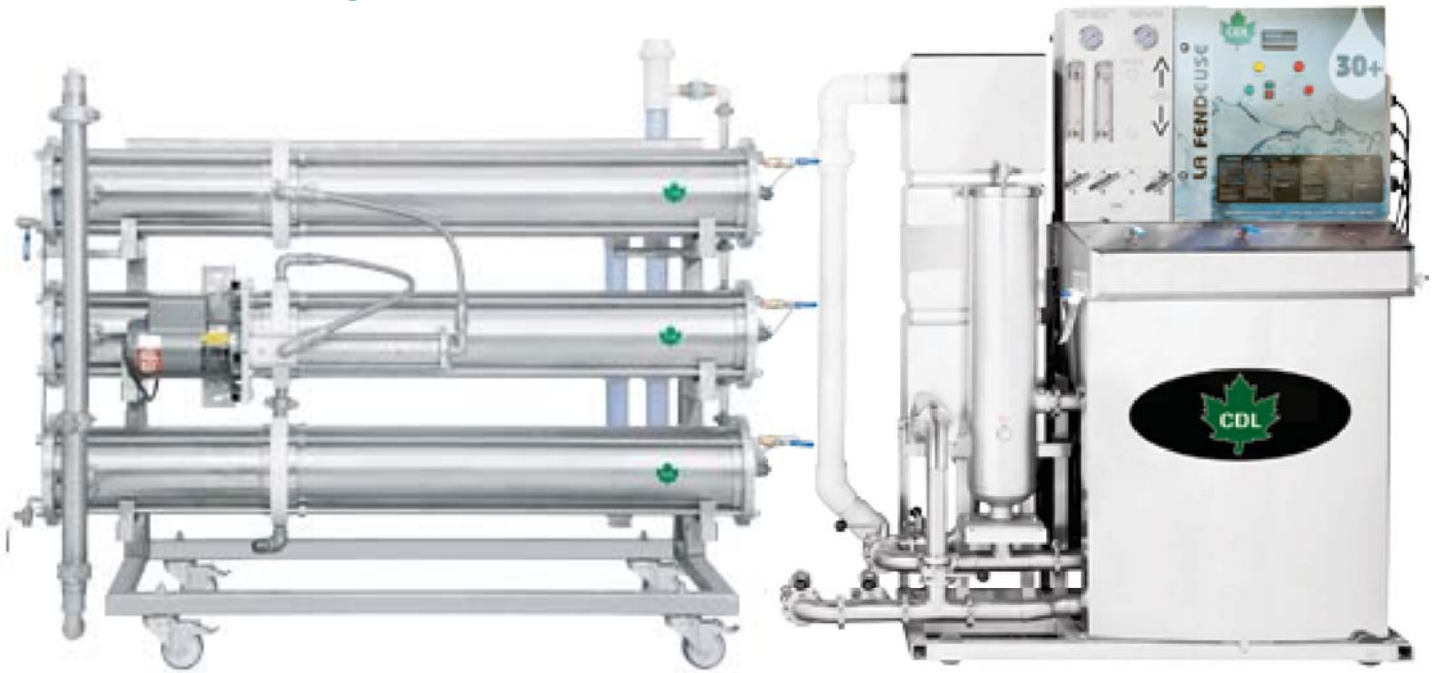

2 models

Three 8-inch post Models;

capacity of
600 gph/ 300 GAL.
concentrated at 30 brix

Six 8-inch post Models;

capacity of
1200 gph/ 600 GAL.
concentrated at 30 brix

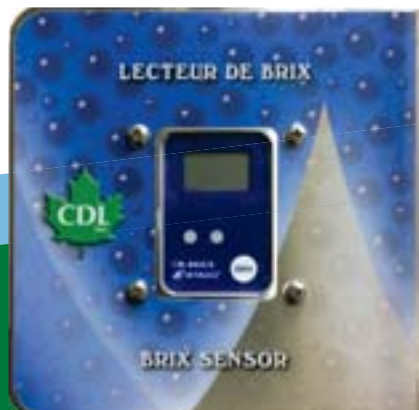

Includes a continuous brix sensor with a modulating valve.
Automatically maintains the desired brix.

REVERSE OSMOSIS ACCESSORIES

CLEANING AND STORAGE SOLUTIONS



Citric acid | 1 kg (powder)
66994 \$14.95



Superflow soap | 1 kg (powder)
66249 \$21.00



Superflow soap | 20 kg (powder)
66239 \$265.00



Organic soap "Superflow green" 4L (Liquid)
66245 \$19.95
FOR ORGANIC CERTIFIED PRODUCERS



Organic soap "Superflow green" 1.2 kg (powder)
662401 \$18.50
FOR ORGANIC CERTIFIED PRODUCERS



Organic soap "Superflow green" 22.7 kg (powder)
662402 \$200.00
FOR ORGANIC CERTIFIED PRODUCERS



Oxysan Cleaner | 4 L
66298 \$49.95



Storage solution | 1 kg
80000 \$11.95



Food grade glycol 20 L
88020 \$94.95

MEASURING INSTRUMENTS



pH 0-2,5 Papers | 50/pkg
668802 \$17.85

pH 10-13 Papers | 50/pkg
668813 \$19.95



Calibration solution pH 10
500 ml
718866 \$21.95



Calibration solution pH 4
500 ml
718865 \$21.95



pH tester Integrated thermometer
665560 \$145.00



pH tester
665514 \$90.50



Portable conductivity tester and thermometer
718855 \$160.00



Portable conductivity tester
718856 \$108.00



Heating element
3 000 W - 240 V
66493 \$45.95



Temperature control
669371 \$160.00

REVERSE OSMOSIS ACCESSORIES

CONTINUOUS BRIX READER



NEW
Continuous brix sensor with modulating valve

668416

This option allows you to precisely control the brix level at the output of your concentrator. The adjustment is done automatically even if the brix of the sap varies.



Continuous brix reader

668417

ADVANTAGES

- > Real time brix reading of concentrate.
- > Can be installed on any R.O.
- > Allows an accurate reading of your adjustment in real-time.

Prices are available upon request

FILTERS



1 1/2" line filter + 24-micron cartridge 6615024	\$99.95
1 1/2" 24-micron filter cartridge only 660024	\$29.75
1 1/2" line filter alone 6615024K	\$73.45
2" line filter + 24-micron cartridge 6620604	\$145.00
2" 24-micron filter cartridge only 660025	\$47.55
2" line filter alone 6620604K	\$109.30



20" complete blue filter housing
665050 \$79.50

MULTIPLE CARTRIDGE HOUSING



Change your osmosis filters in 1 minute!

Extra cartridge support available for quicker changes.

Stainless steel multiple filtration cartridge housing	665056
Interior support only	665068



Prices are available upon request

ADVANTAGES

- > Designed and manufactured by CDL.
- > Quick and easy filter changes.
- > High filtration capacity.
- > Creates no restrictions at the entry of the concentrator

REVERSE OSMOSIS ACCESSORIES

STORAGE CANISTERS

	A	4" Storage canister 724204	\$79.00
	B	8" Storage canister 724225	\$255.00

PREFILTERS

	Pre-filter cartridge 5 mic. 10" 6682101	\$3.95
	Pre-filter cartridge 5 mic. 20" 66821	\$4.45
	10" Filter protectors 12/pkg 66212	\$18.95
	20" Filter protector s 10/pkg 66209	\$21.95
	10" Synthetic filter protectors 12/pkg 66207	\$5.95
	20" Synthetic filter protectors 12/pkg 66208	\$9.95
	6½" plexiglass cover 66270	\$35.95
	10" filtration bag EVBAG100	\$5.95
	20" filtration bag EVBAG200	\$8.95
	30" filtration bag 66823-30	\$13.00
	Nylon screen 36" x 36" NYLSCR	\$15.95

MEMBRANES **NEW**

We offer the best membrane washing service!

Details in-store!









4" CDL Membrane
6604040

8" CDL Membrane
6608040

16" CDL Membrane
6601640

Prices are available upon request

OTHER

	Food grade o-ring grease 6 g 66531	\$3.30
	Food grade o-ring grease 150 g 66535	\$29.85
	Wrench for blue filter 662283V	\$9.65
	10 GPM Bluewhite flowmeter 661042	\$130.00
	1/4" NPT valve X Tube 90° 6622312	\$17.50
	4" membrane U-cup 66402	\$9.50
	8" membrane U-cup 66401	\$15.95

EVAPORATORS
AND ACCESSORIES

MEASURING INSTRUMENTS
AND CLEANING ACCESSORIES

work

ALL YEAR LONG

The adventure begins well before March. The harvest may well be short-lived, businesses run most of the year.

The maple worker must be self sufficient. He must frequently, in all seasons, inspect the sugar bush and prepare for the next season. He must also be versatile because he takes part in the various stages of production and processing. The expertise and quality of the equipment has a real impact on productivity.

BEGINNER BOILING KITS



16" x 16"
kit PRFW16 \$505.00

INCLUDES:

- > 1 R-65 propane burner
- > 1 Hose and regulator
- > 1 16" x 16" sugar pan
- > 1 propane burner support
- > 1 3/4" stainless steel nipple
- > 1 3/4" FIPT stainless steel ball valve



16" x 16"
15 taps kit 6600801 \$630.00

INCLUDES:

- > 1 16" x 16" sugar pan cover
- > 1 16" x 16" sugar pan
- > 1 R-65 propane burner
- > 1 18.5" wooden handle thermometer
- > 1 Orlon filter #8 thick
- > 1 55-70 brix syrup hydrometer
- > 1 8" cup
- > 1 3/4" stainless steel nipple
- > 1 3/4" FIPT stainless steel ball valve

16" x 32" kit PRFW32 \$715.00

INCLUDES:

- > 2 R-65 propane burners (with fastening kit)
- > 2 Hoses and regulators
- > 1 16" x 32" sugar pan
- > 1 16" x 32" propane burner support
- > 1 3/4" stainless steel nipple
- > 1 3/4" FIPT stainless steel ball valve

CLASSIC EVAPORATORS



- > Beginner model. Ideal for approximately 50 taps but can be used for up to 100 taps
- > Can be used outdoors
- > Evaporation of 10 GPH – can make 1 gallon of syrup every 4 hours.
- > Overall dimensions - 26" x 65" x 31" high.
- > Weight without bricks; 257 lb.,
with bricks; 778 lb.

1 pan model

69FBEATK1

Prices are available upon request

INCLUDES:

- > Evaporator base (2'x4').
- > One pan (2'x4').
- > One 3/4" drain-off tap on the side of the pan.
- > 6' of galvanized stack 7" for smokestack.

Not Included:
Cement, bricks and dial thermometer

WOOD EVAPORATORS

HOBBY EVAPORATORS

The CDL Hobby Evaporator is designed for recreational producers who want to enjoy springtime, while boiling small quantities of maple sap to produce a few gallons of maple syrup per season.

18" X 48" Evaporator with 3-way flat pan <i>1 to 75 taps</i>	6700102WD	18" x 60" 5" Flue pan <i>100 to 200 taps</i>	67001DG (LEFT)
18" X 48" Evaporator with combined pan (flat/flue pan) <i>50 to 125 taps</i>	6700102WP	18" x 60" 5" Flue pan <i>100 to 200 taps</i>	67001DD (RIGHT)



18" X 48" INCLUDES:

- > Stainless steel furnace with steel grids.
- > Stainless steel stack.
- > 18" x 48" 304 stainless steel argon welded pan
- > Stainless steel draw-off valve.

AVAILABLE OPTION:

- > Pre-heating pan (code 67112WPARE).

18" X 60" INCLUDES:

- > 18" x 42" Flue pan
- > 18" x 18" Syrup pan
- > Fleet box with rear control level.
- > Complete smoke stack.

Prices are available upon request

SPECIAL HOBBY EVAPORATORS

The CDL special hobby evaporator was designed for recreational producers who wish to have a quality evaporator at a very affordable price. This evaporator will give you the sensation, the comfort and the pleasure of boiling maple sap comparable to that of big producers.



20" X 66" <i>100 to 250 taps</i>	6700202WG (LEFT)	INCLUDES: <ul style="list-style-type: none"> > 32" high furnace with cast iron grates and 2 doors for wood loading. > 1 flue pan with 7" argon welded flues > 1 reversible syrup pan soldered with argon. > Fleet boxes, > Rear and front level control. > High quality cast iron. > 12' long complete chimney (including the stack). > Rope operated stack cover. > Stainless steel connections, drain valve and draw-off valve.
20" X 66" <i>100 to 250 taps</i>	6700202WD (RIGHT)	

Prices are available upon request

PROFESSIONAL EVAPORATORS



The Professional evaporator is a high quality wood evaporator for owners of small sugar bushes. It is designed and manufactured to provide efficient boiling and easy/stable syrup finishing. Its performance in relation to its size will surprise you.

24" X 72"
150 to 450 taps

6700302WG
(LEFT)

24" X 72"
150 to 450 taps

6700302WD
(RIGHT)

INCLUDES:

- > 32" high furnace with cast iron grates and 2 doors for wood loading.
- > 1 flue pan with 7" argon welded flues
- > 1 reversible argon welded finishing pan.
- > Front and rear fleet boxes.
- > High quality cast iron.
- > Complete 12' long chimney (including the stack).
- > Rope operated stack cover.
- > Superior sized combustion chamber for added efficiency (45 % bigger).
- > Stainless steel connections, drain valve and draw-off valve.
- > Water level on flue pan..

Prices are available upon request

THE TRADITIONAL EVAPORATORS

AVAILABLE IN SIZES: 2½' X 8' TO 5' X 16'

The Traditional CDL evaporator is designed for owners of medium and large sugar bushes wishing to keep the tradition alive of boiling the syrup with firewood while being effective and efficient. This evaporator will provide an incomparable boiling stability.

Its robust construction will allow many generations to experience the pleasure of boiling maple syrup.

INCLUDES:

- > 32" high furnace with cast iron grates and 2 doors for wood loading.
- > 1 flue pan with 7" argon welded flues.
- > 2 to 3 argon welded syrup pans for finishing (depending on model)
- > Front and rear fleet boxes.
- > Stainless steel connections, drain valve and draw-off valve.
- > Complete chimney (twice the length of the evaporator) including the stack.
- > 1 rope operated stack cover.
- > Water level on flue pan.



Prices are available upon request

HIGH EFFICIENCY EVAPORATORS



The CDL Chinook Evaporator has an automated air adjustment system that allows a highly efficient, non-polluting combustion, even if the operator burns very poor quality firewood with variable humidity.



2013 EVAPORATOR COMPARATIVE DEMONSTRATION IN ST-ANSELME, QC



Up to
85% efficiency
Available in sizes:
2½' X 8' to 6' X 18'



ADVANTAGES

- > Clean combustion, very little polluting emissions.
- > Complete temperature control in the chimney (maximum 650°F).
- > Time between wood loading: 30 to 60 minutes, depending on quantity.
- > Very efficient and fast start-up and ignition.
- > Boiling stability comparable to pellet and oil evaporators.
- > Very quiet.
- > Combustion creosote free.
- > Very safe.
- > Stable syrup draw-off.

Prices are available upon request

Brix concentration	Wood cords (mixed 24") per syrup barrel (32 gallons)
8	0,45 cord/barrel
10	0,36 cord/barrel
12	0,30 cord/barrel
15	0,24 cord/barrel
18	0,20 cord/barrel

0.24 medium quality wood cord (24") per barrel (32 G) of syrup (15 brix).



HIGH EFFICIENCY EVAPORATORS

The CDL energy efficient Intens-O-Fire wood evaporator is the only one on the market that allows the user to choose between two different types of firewood combustion:
air forced combustion or combustion by gasification.



EVAPORATION COMPETITION
MAPLERAMA 2011

Up to
40% less
wood consumption

Available in sizes:
2½' X 8' to 6' X 18'

Prices are available upon request

FORCED AIR COMBUSTION:

- > Great evaporation rate (Between 4 and 5 gals/ft² of pan surface).
- > 30% less wood consumption than a conventional evaporator.
- > Meets the environmental requirements of greenhouse gas emissions.
- > No soot or creosote.

COMBUSTION BY GASIFICATION:

- > Evaporation from 3 to 3.5 gal/ft² of pan surface.
- > Load every 45 minutes or better.
- > Wood consumption 40% less than a conventional evaporator.
- > Eliminates sparks coming out of the smoke stack.
- > Meets the environmental requirements of greenhouse gas emissions.
- > No soot or creosote.

CDL's Deluxe oil evaporator was designed for small and medium-sized sugar bush producers. This evaporator is very efficient and gives its owner an incomparably comfortable and stable boiling experience. This equipment is very reliable and very simple to operate. **To use it is to adopt it.**



Possibility of 3 types of fuel

Oil
Natural gas
Propane

Available in sizes:
2' X 8' to 6' X 18'

Prices are available upon request



Control panel



Carlin burner

INCLUDES:

- > Oil furnace.
- > Carlin, Beckett or Riello burner.
- > Complete stack with covers and roof jacks.
- > Insulated burner cover.
- > Flue pan and syrup pans.
- > Water level.
- > Front and rear hoods.
- > Front and rear float boxes.
- > Adjustment and start-up by a CDL specialist.

AVAILABLE OPTIONS:

- > Automatic draw-off valve.
- > Syrup drip tray.
- > Hood pre-heater.
- > Permeate pre-filter.
- > Steam pan.

CDL's Tornado Oil Evaporator is an advanced engineering product that has been developed and designed for owners of large sugar bushes. The energy recovery systems integrated into the walls and the bottom of the combustion chamber as well as the one in the chimney will allow to evaporate in power with minimal energy consumption. Its PowerFlame modulating oil burner is installed outside the boiler room to provide the evaporator with maximum fresh air in addition to eliminating noise from the fan guaranteeing an unparalleled comfort.



Possibility of 3 types of fuel

Oil
Natural gas
Propane

Available in sizes:
4' X 15' to 6' X 18'

	4' x 15'	5' x 16'	6' x 16'	6' x 18'
Evaporation gal./hour Without steam pan	300 gals./hour	400 gals./hour	490 gals./hour	520 gals./hour
Evaporation gal./hour With steam pan	450 gals./hour	600 gals./hour	735 gals./hour	780 gals./hour
Oil consumption Without steam pan at 15 brix	0,45 gal. oil/gal. syrup	0,45 gal. oil/gal. syrup	0,45 gal. oil/gal. syrup	0,45 gal. oil/gal. syrup
Oil consumption With steam pan at 15 brix	0,3 gal. oil/gal. syrup	0,3 gal. oil/gal. syrup	0,3 gal. oil/gal. syrup	0,3 gal. oil/gal. syrup
Gal. syrup/hour Without steam pan at 15 brix	52 gals./hour	70 gals./hour	85 gals./hour	91 gals./hour
Gal. syrup/hour With steam pan at 15 brix	79 gals./hour	104 gals./hour	128 gals./hour	136 gals./hour

PowerFlame burner developed exclusively for CDL.

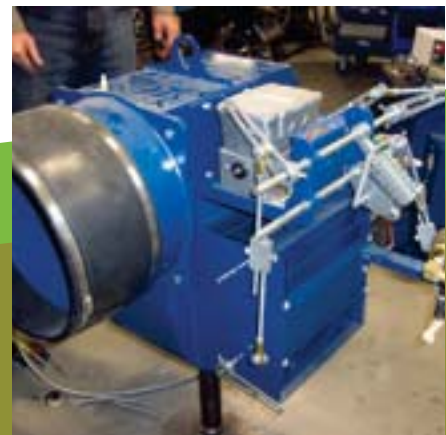

Results in imperial gallons.

Guaranteed Oil Performance and Consumption

WOOD, CHIP OR PELLET EVAPORATORS



The CDL Master Evaporator is the only evaporator on the market evaporating over **5.1 Imp. Gals. / ft²** or **6 U.S. gals. /ft²** of pan.

Wood/chips/wood pellets evaporator
with automatic loading!

Wood Master, available in sizes:
4' X 15' to 6' X 18'



2014 EVAPORATOR DEMONSTRATION
IN ST-ANSELME, QC



www.cdlinc.ca/video.aspx



Wood model shown



New pan concept

pan change in 5 minutes
without stopping the fire

Wood pellet Master, available in sizes:
4' X 15' to 7' X 18'

ADVANTAGES

- > Mechanical system to deviate the heat allowing changes of the finishing pans without stopping the fire. This allows for a very rapid restart of the boiling after a stop.
- > Maximum efficiency
- > No sparks
- > Rear loading of fuel to eliminate dirt caused by wood in the boiler room.
- > No mechanisms near the syrup pans, so no obstruction at the front for the operation of the evaporator.

Ability to produce up to
4½ barrels/hour
(18° brix) with the 7' x 18'
pellet model

Prices are available upon request



OIL EVAPORATORS

The CDL master oil evaporator is the **most productive** and has the best energy efficiency on the market.



Prices are available upon request



New decanter box
to reduce niter
in the syrup pans.
Included with all
Master evaporators.

**0,195 gallons
of oil per
gallon of syrup**

available in sizes:
3' X 11' to 7' X 18'

A revolution in maple sugaring



DESIGN GOALS

- > Have the **best combination** evaporator + concentrator on the market
- > **More flexibility** for producers
- > High-performance evaporation **without traces**
- > **Available range** for producers of 5,000 taps or more
- > **Rapid** Return on Investment
- > Preserve the **flavor** and **authenticity** of the syrup
- > Decrease the boiling time significantly
- > Completely **automated** purification at **100%**
- > Eliminate the risk of burning pans
- > **Offer 3 choices** of fuels: wood, granules, and oil.

Master ^{Concentrator} + 30+

the combination of these
2 new technologies
brings performance and operating
costs to an unprecedented
level in the industry.

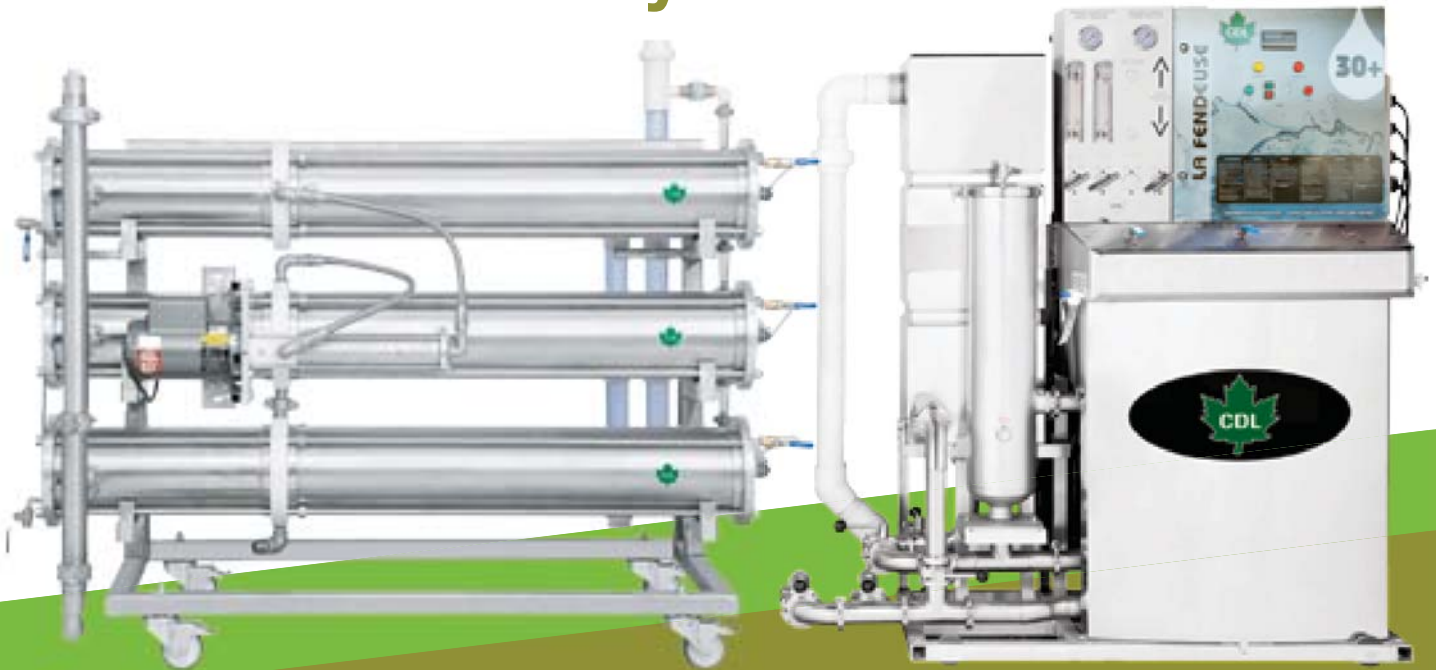

REALISATIONS

- > Better energy + labor costs per barrel on the market
- > Decreased energy costs by at least 40%
- > Complete range available allowing a production from 2 to 7.5 barrels per hour
- > Available in wood, pellets and oil
- > Labor costs for boiling are reduced from 30 to 50%
- > Combination available to produce 14 to 50 barrels per 8-hour work shift

WOOD PELLET EVAPORATORS



CDL's Sirocco evaporator is an **ecological** and **energy alternative** for maple syrup producers.



IMPORTANT decrease
in operating costs compared to oil

Available in sizes:
2½' X 8' to 6' X 18'



Control panel



Installation of a silo is not mandatory for proper operation of the Sirocco.



ADVANTAGES

- > Automated operation similar to an oil evaporator.
- > Burner with power modulation.
- > Very quiet.
- > Comfort of the oil evaporator.
- > Clean combustion with very little pollution.
- > Fast and simple burner shut-off comparable to an oil evaporator.
- > Safe and easy to use.
- > Syrup pans changes can be done very quickly after the shutdown of the burner.
- > Incomparable boiling stability.



Brix Concentrate	Lbs wood pellets per gal. maple syrup	Cost per gal. maple syrup
10	17	\$1.39
12	14	\$1.15
15	11	\$0.90
18	8,75	\$0.72

Based on price of granules at \$180/tonne

EVAPORATOR ACCESSORIES

AUTOMATIC DRAW-OFF VALVES AND LEVEL CONTROLLERS

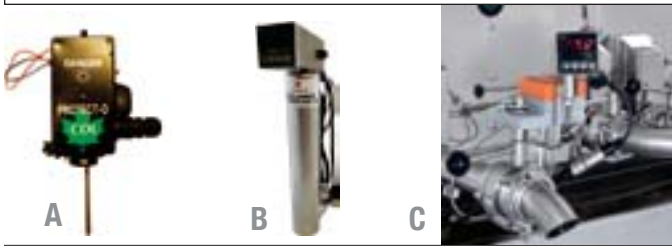

A	Protect-o	66876	\$345.00
B	Modulating draw-off valve 1½"	66771	\$995.00
	Modulating draw-off valve 1½"	66781	\$1 195.00
C	Modulating draw-off valve 2"	66775	\$1 650.00
	Modulating draw-off valve 2 1/2"	66782	\$1 725.00

Clips, silicone gasket and spout not included

ADVANTAGES OF THE MODULATING DRAW-OFF VALVE

- > Allows continuous output of maple syrup.
- > Eliminates the return effect of the syrup into the pans.
- > Eliminates large volume draw-offs.
- > Improve the constancy of the brix level.
- > Facilitates the filtration of maple syrup.

DEFOAMERS

	Liquid 8 oz. EVAN108W	\$7.50
	Liquid 32 oz. EVAM032W	\$24.45
	Liquid 4 L EVAM128W	\$74.95

NEW



Organic defoamer,
Details in store

FOR ORGANIC CERTIFIED PRODUCERS



Kosher 200 g 66890	\$7.50
Kosher 2,5 kg 66898	\$69.95

DRAW-OFF VALVE ACCESSORIES



SPOUTS		
1 1/2"	69BCD150	\$29.50
2"	69BCD112	\$29.95
2 1/2"	69BCD212	\$34.95



OFF CENTERED FERRULES

2" x 1 ½"	60R14215	\$29.95
2 ½" x 2"	60R142122	\$34.95



CLIPS X MIPT FERRULES

2" x 1 ¼"	60R14SW214	\$29.95
2" x 1 ½"	60R14SW215	\$31.00

For clamps and silicone seals see page 77

STACKS AND ACCESSORIES



Chinese hats
Available in diameters
from 6" to 32" and
optional spark guard



Smoke stacks
Available in diameters
from 6" to 32"



Stack covers
Available in diameters
from 7" to 30" and optional
spark guard.



Roof jacks
From 6" to 32" with collar



Base stacks
Available for 2' to 6' width
evaporators

EVAPORATOR ACCESSORIES

STEAM PANS

- > This option can be installed on several types of evaporators (wood, pellet, oil) and several different sizes (2½' x 8' to 6' x 18').
- > The use of the steam pan causes a significant reduction in energy consumption by reusing the steam produced by the flue pan. This reduction in energy consumption can be up to 75% depending on the brix at the input of the pan.
- > In addition, adding this option to the evaporator increases the evaporation capacity by up to 75% without additional fuel consumption.

Improve performance and efficiency

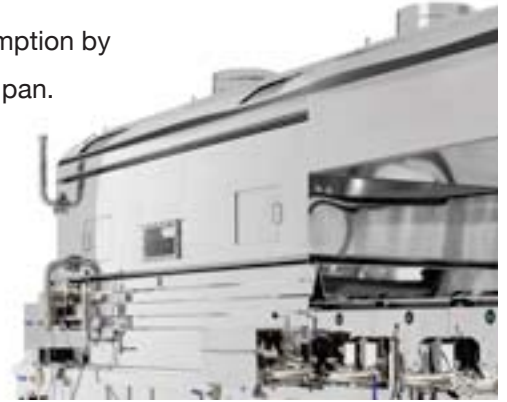

SYRUP PAN WASHERS



Single 2½" 672059

Single 3" 672061

Single 3½" 6720615

Single 4" 672062

Single 5" 672063

Single 6" 672065



Double 2½" 672110

Double 3" 672112

Double 3½" 6721125

Double 4" 672114

Double 5" 672116

Double 6" 672118

Prices are available upon request

Prices are available upon request

Triple syrup pan washer available. Contact your representative for more details.

FLUE PAN WASHER





Eliminate the difficult task of cleaning your flue pan with this highly efficient and performant automatic washer.

- > Complete non-contact wash.
- > Continuous washing circuit.
- > Fits all pans, any brand.
- > Automated and sequential option. Available for Master model.

EVAPORATOR ACCESSORIES

BOILING ACCESSORIES STAINLESS STEEL

	DELUXE CUPS		
	8"	678489	\$40.05
	10"	67847109	\$42.80
	12"	67847129	\$44.85

	STANDARDS CUPS		
	8"	6784789	\$25.45
	10"	6784710	\$30.55

	SMALL CUPS		
	8" (small)	67848901	\$23.40

	DIPPERS		
	Small	678019	\$70.35
	Medium	678029	\$71.40
	Large	67802059	\$72.40

	DIPPERS FLAT-SIDED		
	Small	67802119	\$81.60
	Medium	67802129	\$83.60
	Large	67802109	\$85.65

	SKIMMERS		
	Without holes	6772922007	\$68.35
	With holes	67729220069	\$70.40



	DEFOAMER SUPPORT		
	Small	67ANTIMOUUP	\$11.15
	Large	67ANTIMOUUG	\$14.25

	LIQUID DEFOAMER SUPPORT		
	9 oz	6700009	\$153.00
	16 oz	6700016	\$265.00

	FUNNELS		
	Small	66811	\$57.15
	Large	6681102	\$61.20

	FUNNELS		
	1" X 3/8"	FUNMIN	\$9.15
	5 1/2" x 9/16"	FUNSMMA	\$13.75

	PLASTIC FUNNELS		
	Plastic funnel set (3)	FUNPLA	\$4.60

	FILLING CONTAINERS		
	2L stainless steel with handle	MEACSL	34.25 \$
	4 L with handle (measuring)	MEACU4	28.50 \$

	PADDLES		
	42"	674242	\$81.60

Other sizes available

EVAPORATOR ACCESSORIES

SUGAR PANS STAINLESS STEEL



Valve not included



16" x 16" x 12"	67WP1616	\$265.00	24" x 36" x 12"	67WP2436	\$360.00
16" x 32" x 12"	67WP1632	\$305.00	24" x 48" x 12"	67WP2448	\$425.00
16" x 16" cover	67WPCO16	\$56.00	24" x 72" x 12"	67WP2472	\$495.00
16" x 32" cover	67WPCO32	\$74.00			

WATER JACKETED PANS



Valve not included

Water jacketed pan for sugar pan that can be used for the bottling kit beginning at page 87.

16" x 16"	67316M
16" x 32"	MINS32

Prices are available upon request

SYRUP FILTER TANKS STAINLESS STEEL



US gallons	Imp. gallons				
5,85 gallons (mini)	5 gallons (mini)	Diam. 9"	67MINFIL	\$265.00	
7,6 gallons	6,5 gallons	Diam. 9"	6740006	\$370.00	
10,25 gallons	12 gallons	Diam. 12"	6740026	\$425.00	
23,4 gallons	20 gallons	Diam. 16"	6740326	\$475.00	
30,4 gallons	26 gallons	Diam. 18"	6740426	\$575.00	
45,65 gallons	39 gallons	Diam. 22"	6740626	\$660.00	
53,8 gallons	46 gallons	Diam. 24"	6740726	\$700.00	

Prices include the stainless steel cover and drain valve. All syrup filter tanks are 28" high.

FILTER SUPPORTS



12"	1 hole	67412	\$170.00
16"	1 hole	674161	\$175.00
22"	3 holes	6742211	\$194.00
24"	3 holes	674243	\$200.00

TRIPLE SYRUP FILTER TANKS



Deluxe 100 gal. 67865209

Standard 100 gal. 67865208

Prices are available upon request

EVAPORATOR ACCESSORIES

CLAMPS FOR PAN FERRULES STAINLESS STEEL

CLAMPS



1½"	60R13C112	\$41.95
2"	60R13C2	\$42.95
2½"	60R13C212	\$56.95

HEAVY DUTY CLAMPS



1½"	60R13HC112	\$14.95
2"	60R13HC2	\$15.95
2½"	60R13HC212	\$18.95

SCREW STYLE



1½"	60R13VT112	\$14.95
2"	60R13VT2	\$15.95
2½"	60R13VT212	\$18.95

GLASS TUBES FOR WATER LEVEL



5/8" x 8	60PEN58X6PLAGL	\$20.35
5/8" x 12	672176	\$23.40
5/8" x 18	60PEN58X18PLAGL	\$27.50
1½" x 8	675157	\$28.50
1½" x 18	60GROSNIIVEAU18	\$40.75

SILICONE GASKETS FOR FERRULES



1½"	60GASKET112SILI	\$3.60
2"	60GASKET2SILI	\$4.05
2½"	60GASKET212SILI	\$6.10

BUTTERFLY VALVES



1½"	60T150	\$150.00
2"	60P88CC2	\$175.00
2½"	60T212	\$225.00

BLUE PLUGS WITH LONG ARM



1½"	678117112	\$35.65
2"	678117	\$40.30
2½"	6781171	\$45.85

HIGH TEMPERATURE PRODUCTS



Silicone
60YYYCSL503 \$14.95



Small brick 2 500 °F
1¼" X 4½" X 9"
66869 \$2.75



Large brick 3 000 °F
2½" X 4½" X 9"
66868 \$4.60



Brick cement
Pyromix, 1 gallon \$35.95
66866

Brick cement
Pyromix, 4 gallons \$89.95
668664

Dry cement, 2 Kg bag \$61.99
66875



Fiber glass wool rope
60TXP018 \$0.95/ft



Ceramic wool
1' x 4' x 25' | 8 lb \$4.50/ft²
100 pi²/boite
60BKT18LB100A

Ceramic wool
1/2" x 4' x 50' | 8 lb \$3.25/ft²
200 pi²/boite
60BKT18LB050A



Thermofab wool
2" x 1/8" \$1.30/ft
Rouleau 100'
60GW300100



Ceramic wool
6 lb x 2" \$23.75
Rouleau de 25'
EBCB2425A



Ceramic wool panel
1" x 12" x 36" \$19.95
EBISOL06

MEASURING INSTRUMENTS



CENTER PRODUCT



International syrup grading kit
662396 \$52.00



Syrup grading kit
Old Canadian Standards
662390 \$35.00



Flavor defect testing kit
662395 \$48.00



Specially designed and developed
by the Acer Center to calibrate refractometers
for brix maple syrup measurement

Calibrating solution for refractometers
66616 \$20.00



Maple syrup
production
register
(French only)
ECB004 \$20.00



Health guide
for sugarbushes
(French only)
ECB001 \$30.45



Guide:
Disinfection
method with
isopropyl alcohol \$10.00
ECB002 French version
ECB003 English version

REFRACTOMETERS

SAP



Sap
ATAGO
Brand 0-32 brix 6684001 \$399.00

SAP AND SYRUP



Water	0-32 brix	EIRE0032C	\$99.00
Syrup	45-82 brix	EIRS4582C	\$99.00



DIGITAL
0-85 brix 668412 \$635.00

COLORIMETERS



Portable electronic
French/English
HANNA Brand
662379 \$398.00



Sample bottle only (1,75")
662378 \$0.46



Sample bottle (3,75") + cap	668888	\$0.65
Sample bottle (3,75")	668887	\$0.52
Cap only	668889	\$0.12

MEASURING INSTRUMENTS

HYDROMETER SAP AND SYRUP

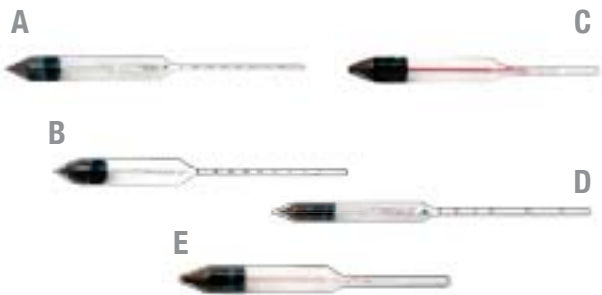

A	Sap	0-6 brix	EIDE2010	\$19.95
B	Sap	0-15 brix	668433	\$19.95
C	Sap	10-25 brix	66849	\$21.65
	Syrup	45-75 brix <small>(Vermont state approved)</small>	EIDS4575	\$21.50
D	Syrup	55-70 brix	66845	\$16.95
E	Syrup	Hydrotherm	66841	\$30.95

DIAL THERMOMETERS

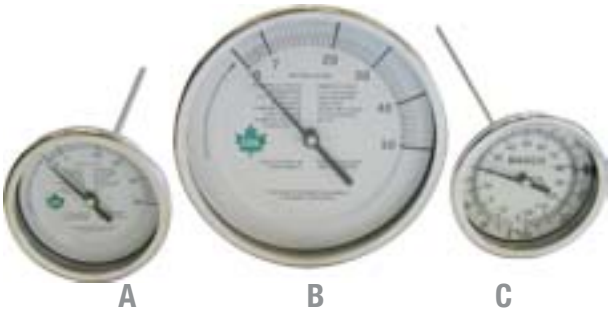

A	3" Dial 9" 0-50 °F ¼" MIPT	72920003	\$49.95
	3" Dial 12" stem 0-50 °F ¼" MIPT	72920004	\$59.95
B	5" Dial 9" stem 0-50 °F ¼" MIPT	72920001	\$49.95
	5" Dial 12" stem 0-50 °F ¼" MIPT	72920002	\$54.95
	3" Dial 12" stem 0-250 °F ½" MIPT	668350	\$75.00
	3" Dial 6" stem 0-50 °F ¼" MIPT	EITC0306	\$47.95
C	3" Dial 6" stem 0-250 °F ¼" MIPT	EITC0336	\$43.25
	3" Dial 9" stem 0-250 °F ¼" MIPT	EITC0330	\$49.95
	3" Dial 6" stem 200-1000 °F ½" For evaporator smoke stack	668210	\$64.95

OTHER THERMOMETERS



12"
71750425 \$34.95



With wooden handle
66836 \$79.95



12" | Stainless steel
71750426 \$19.95



6" barometer
72920030 \$195.00









Electronic | 18" probe
668204 \$395.00

CLEANING ACCESSORIES





BRUSHES FOR PANS AND TANKS

	2" x 7" without handle 663524	\$21.50		4" x 7" pan brush 72940050	\$38.65
	2" x 7" flue brush 663521	\$19.50		9" handle EVBRE001	\$7.25
				20" handle EVBRE003	\$10.75
	1/2" x 7" flue brush 66352	\$21.95		No handle round tank brush 66356	\$29.95

TUBING AND SPOUT SANITIZERS

				Isopropyl alcohol sold by CDL is approved by the Canadian Food Inspection Agency.		
				A	Isopropyl 70%, 18,9 L	667470
				B	Isopropyl 70%, 205 L	6674277
				C	Pure denatured, 4 L	667575
				D	Chlorine 12 % 20 L	666000
			E	Peroxide, 2.5 gallons	66289	

PAN CLEANERS

			
A	Sani-clean 4 L	66284	\$27.25
A	Sani-clean 20 L	66288	\$135.00
B	99% Glacial acetic acid 20 L	667474	Price upon request
POWDERED PAN ACID FOR STAINLESS STEEL			
	3 lb	EVNSS300	\$17.25
	10 lb	EVNSS010	\$51.00
	25 lb	EVNSS250	\$95.00
	1 gal.	EVPAN40W	\$19.95
	5 gal.	EVPAN5GW	75.00 \$

FILTER PRESSES
AND ACCESSORIES

BARRELS, PROCESSING
EQUIPMENT AND ACCESSORIES

an INTENSE season

Gently, winter has passed and the sugaring season is on our doorstep. Freezing nights are followed by days of thaw. For producers then begin one to two intense months that require dedication, energy and passion.

Although producers often prefer to maximize the short sugaring period by harvesting sap through a tubing system that brings sap to the processing site, the short season will often require a producer to devote intensity and energy for nearly 120 hours per week.

FILTER PRESSES

FILTER PRESSES WITHOUT PUMP AND CART

Assembled with all pump models shown in the section below.



7" Press

10" Press



20" press 3 holes
Filtration capacity: 15 to 50 barrels

7" short press 3 hollow plates, 2 full plates	666070
7" standard press 6 hollow plates, 5 full plates	6660007
10" short press 3 hollow plates, 2 full plates	6660010C
10" standard press 6 hollow plates, 5 full plates	6660010
10" long press 7 hollow plates, 6 full plates	6660010L
20" press (max. 9 hollow plates) 7 hollow plates, 6 full plates	666217

Individual additional plates, available in 7", 10" and 20"

ADVANTAGES

- > Higher filtration capacity.
- > Plate thickness: 2" for the 7" press, 2½" for the 10" press and 3" for the 20" press.
- > Easier assembly of filter papers.

AVAILABLE OPTIONS:

> Brass gear pump	730016
> ½" diaphragm pump	730019
> 1" diaphragm pump	730020
> 7" and 10" filter press cart	66606

Prices are available upon request

FILTER PRESS PUMPS



½" Oberdorfer pump 664000BR



Aluminum

½" Diaphragm pump 669585



½" Oberdorfer pump repair kit 664000BR1



Aluminum

1" Diaphragm pump 669601

SELF CLEANING FILTER PRESSES

PENDING
PATENT
CDL



INCLUDES:

- > Support
- > Drain Manifold with valves
- > Pressure Gauges

Self-cleaning 10" press
7 hollow plates, 6 full plates

6660010A

NOT INCLUDED:

- > Pump option
- > Feed and drainage (washing water) plumbing

Caution

Requires the use of an air compressor and a good supply of water or permeate.

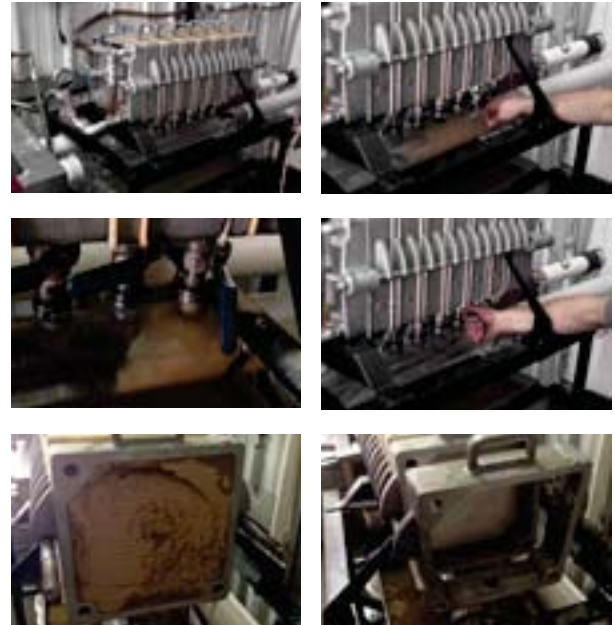

ADVANTAGES

- > Technology that revolutionizes the cleaning operation of syrup press plates.
- > De-sugaring and washing the plates without any syrup loss.
- > Ultra fast and very efficient washing without removing the plates.
- > Takes only **5 minutes** to wash the plates and repeat the filtration process
- > Reduces the cost of using filter papers by **90%**.

Prices are available upon request

DRAW OFF TANK WITH PRESS



Can be assembled with all pump models shown on the previous page. Mounting available on single tank (35 gallons) or double tank (2 x 35 gallons).

Multifunctional and very compact.

FILTER PRESSES

WESFAB FILTER PRESSES

We are very proud to now be the exclusive supplier of these high-performance filter presses designed and manufactured in the United States. These will now be distributed throughout North America through our distribution network.



A	7" manual press	WF07H	
	7" short press Gear pump, 3 hollow plates, 2 full plates	WF07C	
	7" short press 1/2" diaphragm pump 3 hollow plates, 2 full plates	WF07CD2	
B	7" standard press Gear pump 8 hollow plates, 7 full plates	WF07	
	7" standard press 1/4" diaphragm pump 8 hollow plates, 7 full plates	WF07D	
	10" short press Gear pump, 3 hollow plates, 2 full plates		WF10C
	10" short press 1/2" diaphragm pump 3 hollow plates, 2 full plates		WF10CD
	10" standard press Gear pump, 8 hollow plates, 7 full plates		WF10
	10" standard press 1/2" diaphragm pump 8 hollow plates, 7 full plates		WF10D











15" press 1" diaphragm pump 7 hollow plates, 6 full plates	WF15D1	7" Wesfab press cart	EVPFW101W
15" long press 1" diaphragm pump 10 hollow plates, 9 full plates	WF15D1L	10" Wesfab press cart	EVPFW301W

Prices are available upon request

FILTER PRESS ACCESSORIES

ACCESSORIES

	5 1/4" filter papers 66817	\$29.35 / pkg 200		Cone pre-filters 66206	\$15.45 / pkg 12
	7" filter papers 66828	\$55.95 / pkg 400		Flat pre-filter paper 24" x 24", woven style PREW24	\$2.60
	10" filter papers 66829	\$89.95 / pkg 400		Flat pre-filter paper 36" x 36", woven style PREW36	\$2.70
	15" filter paper 668015	\$0.89 / unit		36"x36" pre-filter paper Coffee style PREC36	\$2.95
	20" filter paper 2 holes 668221	\$0.95 / unit		Cone pre-filter paper woven style PREWCO	\$1.60
	10" filter papers with wings 66801	\$79.95 / pkg 400		Cone pre-filter paper coffee style PRECCO	\$1.85
	20" filter paper 3 holes with wings 668224	\$1.29 / unit		Bucket filter FILBAG	\$25.25
	7" press felt filters 66827	\$26.95 / pkg 12		Bucket pre-filter PREWFI	\$6.50
	10" press felt filters 66830	\$28.95 / pkg 12		Sap filters 12" X 24" 66248	\$22.35 / pkg 2
	20" press felt filters 2 holes 66820	\$86.95 / pkg 7		Sap filters 24" X 24" 66210	\$29.95 / pkg 2
	20" press felt filter 2 double holes 668206	\$19.85 / unit		24" X 24" flat filter FILF24	13.50 \$
	20" press felt filters 3 double holes 66850	\$115.50 / pkg 7		36" X 36" flat filter 66211	\$14.50
	Self-cleaning press felt filters 66852	\$39.95 / pkg 16		545 Celite filter aid 10 lb 66825	\$16.95
	Orlon #8 felt cone 66815	\$17.85		545 Celite filter aid 50 lb 66826	\$41.25
	Polyester #8 felt cone 66814	\$13.95		Decalite filter aid 50 lb 66838	\$41.25
	Food grade grease 66530	\$11.15			

BARRELS AND ACCESSORIES

BARRELS STAINLESS STEEL

The CDL barrel is designed according to the recommendations of the Federation of maple syrup producers and "Table Filière".

13 gallons (15,7 US gallons)
66819

33 gallons (40 US gallons)
66816

45 gallons (55 US gallons) **NEW**
668161

Prices are available upon request



ADVANTAGES

- > All lower joints completely welded.
- > Designed for the complete drainage of syrup or washing water.
- > Drip hole on top; No hole on the side.
- > Edges with pronounced curves facilitating the handling of the barrels.
- > Same dimensions as conventional galvanized barrels.
- > Stackable.



3/4" zinc cap	66792	\$2.80
2" zinc cap	66794	\$4.70
2" plastic cap <small>(Can be used with bag 663332)</small>	660057	\$1.60
2" stainless steel cap	BUNGSS	\$17.95
2" plastic cap for barrels <small>(Large thread / hole 3/4" NPT in center)</small>	BUNG06	\$6.95

HANDLING ACCESSORIES FOR BARRELS



3-wheel stainless steel cart
676055S \$520.00



Stainless steel lever
671092 \$78.50



Barrel trolley
DRUOC \$199.95





Barrel lifter with pulley and cord
665045 \$375.00

PROCESSING EQUIPMENT





BARREL ACCESSORIES

	Stainless steel barrel sampler 67ECHBA	\$49.95		Stainless steel health barrel key 662285	\$21.25
	32-gallon plastic bag 663332	\$9.50		Barrel wrench BARWRE	\$69.95
	Stainless steel plastic bag holder 678952	\$35.00		Barrel wrench 662282	\$49.95

PUMP AND BARREL TRANSFER

	Pneumatic stainless steel barrel pump	DRUPUM	\$199.95
<p>ADVANTAGES</p> <ul style="list-style-type: none"> > Allows you to empty a barrel of syrup faster > Quicker than a pump > Empty barrels of syrup without making a mess > Very easy to use 			
	1" Teflon barrel transfer	6150P1	\$185.00
	5/8" Teflon barrel transfer	6150P58	\$185.00

BEGINNER BOTTLING KITS

   	 <p style="color: red; border: 1px solid red; border-radius: 50%; padding: 5px; display: inline-block;">With Adjustable Shelf</p>	<p>Beginner bottling kit</p> <p>INCLUDES:</p> <ul style="list-style-type: none"> > 1 16" x 16" sugar pan cover > 1 16" x 16" sugar pan > 1 16" x 16" filter holder > 1 R-65 propane burner > 1 1/2" FIPT stainless steel ball valve > 1 16" x 16" water jacketed tank > 1 propane burner support > 1 3/4" stainless steel nipple > 1 1/2" stainless steel nipple > 1 3/4" FIPT stainless steel ball valve 	<p>6600802</p> <p>\$970.00</p>
	<p>16" x 32" kit</p> <p>INCLUDES:</p> <ul style="list-style-type: none"> > 1 16" X 32" sugar pan cover > 1 16" X 32" sugar pan > 1 16" X 32" filter holder > 2 R-65 Propane burners > 1 16" X 32" water jacketed tank > 1 propane burner support > 1 3/4" stainless steel nipple > 1 1/2" stainless steel nipple > 1 3/4" FIPT stainless steel ball valve 	<p>PFF32K</p> <p>\$1 425.00</p>	

PROCESSING EQUIPMENT

MAPLE CREAM MACHINES



Demonstration at
www.cdlinc.ca/video.aspx



Maple cream machine 8 L 110 V	Brass pump	668828
Maple cream machine 16 L 220 V	Brass pump	668827
Maple cream machine 8L 110 V	Stainless steel pump	668828S
Maple cream machine 16L 220 V	Stainless steel pump	668827S

MAPLE SUGAR MACHINES



Single:
Capacity of 17 lb.



Double:
Capacity of 35 lb.

8" automatic maple sugar machine	668855A
8" double automatic maple sugar machine	668856A

ADVANTAGES

- > Fully automated
- > Uniform granulation
- > Can function without supervision
- > Available without automation if requested
- > Made of stainless steel
- > 3 in 1: mixer, grinder and dryer
- > Self-cleaning with hot water

WATER JACKETED TANKS



Electric water
jacketed tank
35 gallons
67422

Bottling stand
with pedal
35 gallons
67220-S

Stainless steel



Electric water
jacketed tank
12 gallons
67422-M

Bottling stand
with pedal
12 gallons
67220-MS

Stainless steel



3/8"
bottling valve
67215

5/8"
bottling valve
67216

PROCESSING EQUIPMENT

CAN SEALERS



Ives Way manual can sealer
66774



Master manual can sealer
66777



Master automatic can sealer
66824

Prices are available upon request

OTHER



Candy machine
(motor included)
ECB0100A \$1 795.00



Auger and pan
ECBMW301 \$395.00



Extra pan
ECBMP101 \$430.00

Motor 1/4 hp
660002 PRICE sur demande



Propane burner
R-65 \$83.95
66803



Electric bottling valve
Includes 3 stainless steel tips:
1/4", 3/8", 1/2" \$495.00
67217



Bottling nozzle for water
jacketed tank
3/8" elbow x 3/4" mipt \$25.00
67BM12



Bottling valve
1/2", 90° \$30.85
ECDVP805



Bottling valve
3/8", 90° \$37.50
ECDVP804



Coffee pot style
spout + gasket \$19.95
COFSP0



Bottle/container washer
BOTWAS \$24.95



Bottling nozzle for
water jacketed tank
1/2" elbow x 1/2" mipt \$13.00
6788991B2

CANS
AND ACCESSORIES

BOTTLES, PACKAGING,
BOOKS AND ACCESSORIES

maple ON THE TABLE

Nobody really knows how the Native Americans discovered the existence of maple sap nor how they managed to transform it.

There is quite a potential of flavors for cooking, which are otherwise impossible to create. Today, maple syrup is more sophisticated, the packaging is improved and the market is now worldwide.

Syrup, sugar and maple cream are well known. For some time, we have noticed on the shelves new products drawn from maple. Maple pearls, vinaigrettes, sauces, sweets... Even meat, soups and vegetables are delectable when enhanced with the discreet presence of maple.

Be that as it may, maple syrup is a real treasure. Versatile, it lends itself happily to the preparation of many sweet or savory dishes, from the appetizer to the dessert. Enjoy your meal!

CANNES AND ACCESSORIES

ROUND CANS



Pure maple syrup
540 ml, 200/case 663025

Organic
540 ml, 200/case 663026
Organic certificate required for purchase.

Prices are available upon request



Lithograph
exclusive to



MISCELLANEOUS CANS FRENCH/ENGLISH LITHOGRAPH



250 ml	65/ case	CAN250
500 ml	40/ case	CAN500
1L	24/ case	CAN001

Prices are available upon request

250 ml	100 / case	EXTC0250C
500 ml	100 / case	EXTC0500C



CARDBOARD BOXES FOR CANS



8 x 540 ml box
Package of 25
66832 \$16.50



8 x 540 ml box
with handle
Package of 25
66834 \$18.75



24 x 540 ml box
Package of 25
66833 \$24.50

BOTTLES AND PACKAGING

MODERN AND MAPLE LEAF

CAPS NOT INCLUDED

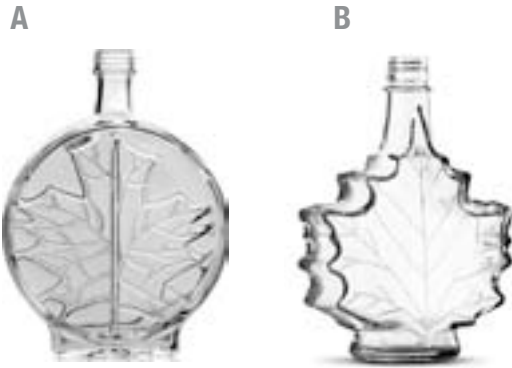

	SIZE	PRODUCT CODE	QTY/BOX	PRICE	CAP CODE
A	MODERN				
	50 ml	EXBV0050M	50	\$1.10	661378 (GOLD)
	100 ml	EXBV0100M	36	\$1.15	661374 (GOLD)
	250 ml	EXBV0250M	12	\$1.90	661374 (GOLD)
	500 ml	EXBV0500M	12	\$2.60	661388 (GOLD)
B	MAPLE LEAF				
	50 ml	EXBV0050AU	48	\$1.30	661378 (GOLD) CAPK25 (BROWN)
	100 ml	EXBV0100AU	12	\$2.80	661374 (GOLD) CAPK25 (BROWN)
	250 ml	EXBV0250AU	12	\$3.00	661374 (GOLD)
	500 ml	EXBV0500AU	12	\$4.35	661388 (GOLD) CAP500 (BROWN)
	750 ml	EXBV0750AU	6	\$6.45	661388 (GOLD) CAP500 (BROWN)

GALLONE

CAPS NOT INCLUDED



	SIZE	PRODUCT CODE	QTY/BOX	PRICE	CAP CODE
A	GALLONE				
	40 ml	EXBVRH50	48	\$0.59	661378 (GOLD)
	100 ml	BOTH01	24	\$1.30	661377 (BLACK)
	250 ml	EXBVRH250	12	\$1.55	661377 (BLACK) 661390 (BROWN)
	500 ml	EXBVRH500	12	\$1.75	661377 (BLACK) 661390 (BROWN)
	1 L	EXBVRH1000	6	\$2.75	661377 (BLACK)
	½ gal.	EXBVRH2000	6	\$2.80	661391 (BROWN) 661381 (WHITE)
	1 gal.	EXBVRH4000	4	\$3.75	661391 (BROWN) 661381 (WHITE)
B	250 ml	EXBV0250GL	20	\$1.35	661376 (WHITE) CAP500 (BROWN)
	500 ml	EXBVRH500M	12	\$1.75	CAP500 (BROWN)

FLAT

CAPS NOT INCLUDED



	SIZE	PRODUCT CODE	QTY/BOX	PRICE	CAP CODE
A	FLAT				
	250 ml	EXBV0250L	12	\$0.85	661376 (WHITE) 661384 (BROWN)
	375 ml	EXBV0375	12	\$1.15	661376 (WHITE) 661384 (BROWN)
	500 ml	EXBV0500	12	\$1.25	661376 (WHITE) 661384 (BROWN)
B	8 oz	EXBV0252	12	\$0.80	661376 (WHITE) 661384 (BROWN)
	12 oz	EXBV0377	12	\$1.05	661376 (WHITE) 661384 (BROWN)

GINGER BREAD AND FLASK



	SIZE	PRODUCT CODE	QTY/BOX	PRICE	CAP CODE
A	GINGER BREAD				
	250 ml	EXBV0250PE	12	\$2.58	661374 (GOLD)
B	GINGER BREAD				
	50 ml	EXBV0050PEEV	48	\$1.20	661378 (GOLD)
	100 ml	EXBV0100PEEV	24	\$1.50	661374 (GOLD)
	250 ml	EXBV0250PEEV	12	\$2.58	661374 (GOLD)
C	FLASK				
	200 ml	BOTHF2	12	\$1.00	661384 (BROWN) CAP500 (BROWN)

Very competitive skid pricing.
Call your local CDL store for details.

BOTTLES AND PACKAGING

DECANTER AND ROYAL

CAPS NOT INCLUDED



	SIZE	PRODUCT CODE	QTY/BOX	PRICE	CAP CODE
A	DECANTER				
	16 oz	EXBV016	12	\$0.86	661381 (WHITE)
	32 oz	EXBV032	12	\$1.70	661381 (WHITE)
B	ROYAL				
	50 ml	BOTR50	48	\$0.83	CAPK25 (BROWN)
	125 ml	EXBV0125R	24	\$0.97	CAPK25 (BROWN)

LIMITED QUANTITY

GRAND LINE AND SAUCE

CAPS NOT INCLUDED

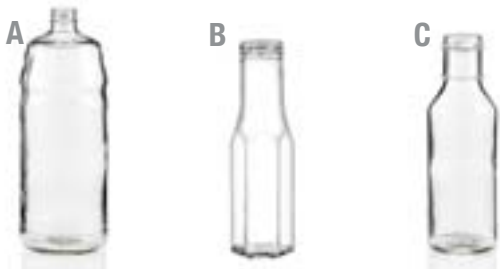

	SIZE	PRODUCT CODE	QTY/BOX	PRICE	CAP CODE
A	GRAND LINE				
	1 L	EXBV1000G	12	\$1.25	661376 (WHITE) 661386 (BROWN) 661384 (BROWN)
	SAUCE				
B	250 ml	BOTSH2	12	\$1.33	728445 (MÉTAL)
C	350 ml	EXBV0350S	12	\$0.65	728438 (MÉTAL)

WHISKY AND RELIEF

CAPS NOT INCLUDED



	SIZE	PRODUCT CODE	QTY/BOX	PRICE	CAP CODE
A	WHISKY				
	50 ml	BOTW5018SC	96	\$0.58	CAP05B (BLACK)
	1 L	EXBV1000S	12	\$1.26	661393 (BROWN) 661384 (BROWN)
B	RELIEF				
	200 ml	EXBV200M	12	\$1.42	661376 (WHITE) 661384 (BROWN)

CAPS

WHITE PLASTIC CAPS

	20 x 400 mm	CAP050	\$0.10
	28 x 400 mm	661376	\$0.10
	38 x 400 mm	661381	\$0.10

GOLD PLASTIC CAPS / TEMPER EVIDENT

	18 x 400 mm	661378	\$0.17
	24 x 400 mm	661374	\$0.18
	28 x 400 mm	661388	\$0.20

BROWN PLASTIC CAPS

	24 x 400 mm	CAPK25	\$0.12
	28 x 400 mm	661384	\$0.10
	31.5 x 400 mm	661390	\$0.15
	38 x 400 mm	661391	\$0.11
	22 x 410 mm	CAPE25	\$0.12
	28 x 410 mm	CAP500	\$0.15

BLACK PLASTIC CAPS

	18 x 400 mm	CAP05B	\$0.12
	28 x 400 mm	CAPKB5	\$0.16
	31,5 x 400 mm	661377	\$0.19

METAL LIDS

	38 mm	728438	\$0.10
	43 mm	728445	\$0.14



PLASTIC CAPS / TEMPER EVIDENT

(WHITE)	28 x 400 mm	661382	\$0.12
(GOLD)	28 x 400 mm	661385	\$0.18
(BROWN)	28 x 400 mm	661393	\$0.10
(BROWN)	28 x 400 mm	661386	\$0.10

BOTTLES AND PACKAGING

NEW MODELS 2017 NEW

LIMITED QUANTITY

CAPS NOT INCLUDED

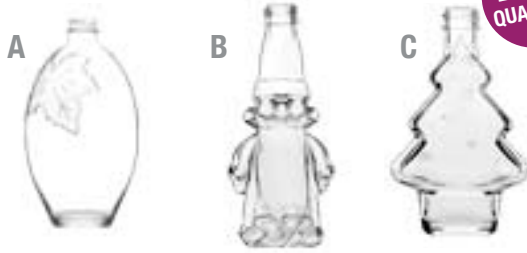

	SIZE	PRODUCT CODE	QTY/BOX	PRICE	CAP CODE
A	100 ml	EXBV0100TA	12	\$3.10	661376 (WHITE)
					661379 (BLACK)
					661384 (BROWN)
B	200 ml	EXBV0200GN	12	\$3.25	661376 (WHITE)
					661379 (BLACK)
					661384 (BROWN)
C	200 ml	EXBV0200CT	12	\$3.25	661376 (WHITE)
					661379 (BLACK)
					661384 (BROWN)

BASQUAISES

CAPS NOT INCLUDED



	SIZE	PRODUCT CODE	QTY/BOX	PRICE	CAP CODE
	100 ml	EXBV0100B	12	\$1.30	661374 (GOLD) CAPK25 (BROWN)
	250 ml	EXBV0250B	12	\$1.38	661376 (WHITE) 661384 (BROWN)
	500 ml	EXBV0500B	12	\$2.75	661377 (BLACK)

BASQUAISE SNOWMAN

CAPS NOT INCLUDED



	SIZE	PRODUCT CODE	QTY/BOX	PRICE	CAP CODE
	250 ml	EXBV0250BSM	12	\$4.05	661376 (WHITE) 661384 (BROWN)

BASQUAISE 4 SUGARING SCENES

CAPS NOT INCLUDED



	SIZE	PRODUCT CODE	QTY/BOX	PRICE	CAP CODE
	250 ml	EXBV0250BI	12	\$4.05	661376 (WHITE) 661384 (BROWN)

BASQUAISE 4 CHRISTMAS SCENES

CAPS NOT INCLUDED



	SIZE	PRODUCT CODE	QTY/BOX	PRICE	CAP CODE
	250 ml	EXBV0250BC	12	\$4.05	661376 (WHITE) 661384 (BROWN)

Very competitive skid pricing.
Call your local CDL store for details.

BOTTLES AND PACKAGING

BASQUAISES ANIMALS

CAPS NOT INCLUDED

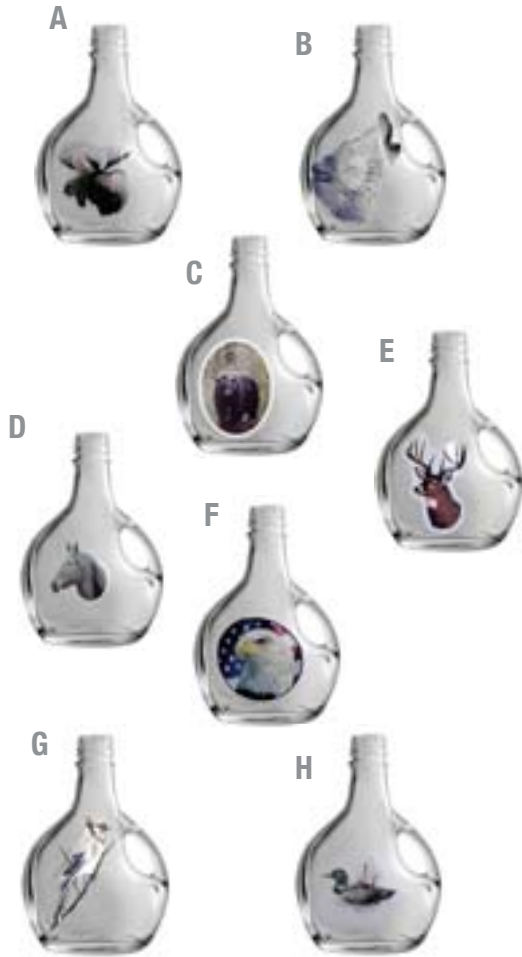

	SIZE	PRODUCT CODE	QTY/BOX	PRICE	CAP CODE
A	MOOSE				
	250 ml	EXBV0250BP Moose	12	\$4.05	661376 (WHITE) 661384 (BROWN)
B	WOLF				
	250 ml	EXBV0250BP Wolf	12	\$4.05	661376 (WHITE) 661384 (BROWN)
C	BEAR				
	250 ml	EXBV0250BP Bear	12	\$4.05	661376 (WHITE) 661384 (BROWN)
D	HORSE				
	250 ml	EXBV0250BP Horse	12	\$4.05	661376 (WHITE) 661384 (BROWN)
E	DEER				
	250 ml	EXBV0250BP Deer	12	\$4.05	661376 (WHITE) 661384 (BROWN)
F	EAGLE				
	250 ml	EXBV0250BP Eagle	12	\$4.05	661376 (WHITE) 661384 (BROWN)
G	BLUE JAY				
	250 ml	EXBV0250BP Jay	12	\$4.05	661376 (WHITE) 661384 (BROWN)
H	LOON				
	250 ml	EXBV0250BP Loon	12	\$4.05	661376 (WHITE) 661384 (BROWN)

Very competitive skid pricing.
Call your local CDL store for details.

PLASTIC CAPS SUITABLE FOR BASQUAISE BOTTLES

WHITE PLASTIC CAPS



28 x 400 mm 661376 \$0.10

BROWN PLASTIC CAPS



24 x 400 mm	CAPK25	\$0.12
28 x 400 mm	661384	\$0.10
28 x 410 mm	CAP500	\$0.15
31.5 x 400 mm	661390	\$0.15

BLACK PLASTIC CAPS



28 x 400 mm CAPKB5 \$0.16

GOLD PLASTIC CAPS



24 x 400 mm 661374 \$0.18

HEAT SHRINK CAPS FOR GLASS BOTTLES



28 mm, 100/box EXCAP028G \$14.95

31 mm, 100/box EXCAP031G \$14.95

GOLD CAPS FOR GLASS BOTTLES



30,5 x 42 mm, 100/box EXCAP210 \$8.95

34 x 52 mm, 100/box EXCAP310 \$11.25

BOTTLES AND PACKAGING

HEXAGONAL JARS

LIDS NOT INCLUDED



SIZE	PRODUCT CODE	QTY/BOX	PRICE	CAP CODE
45 ml	EXPOH045-24	24	\$0.40	728445
110 ml	EXPOH110-12	12	\$0.62	72843000
190 ml	EXPOH190-12	12	\$0.81	788490
270 ml	EXPOH270-12	12	\$1.00	788470

SHORT ROUND JARS

LIDS NOT INCLUDED



SIZE	PRODUCT CODE	QTY/BOX	PRICE	CAP CODE
30 ml	BOTM30	160	\$0.47	728445
40 ml	EXPO40	24	\$0.53	728445
55 ml	BOTM02	96	\$0.57	72843000
125 ml	EXPO125	12	\$0.53	72843000
250 ml	EXPO250	12	\$0.59	728470
375 ml	BOTS37	12	\$0.91	728470
750 ml	BOTS75	12	\$1.12	CAPG82

LONG ROUND JARS

LIDS NOT INCLUDED



SIZE	PRODUCT CODE	QTY/BOX	PRICE	CAP CODE
250 ml	BOTT25	12	\$0.75	CAPG53
375 ml	BOTT37	12	\$0.63	788490
500 ml	BOTT50	12	\$0.67	788470
750 ml	BOTT75	12	\$1.12	728470

EMBOSSED HONEY JAR

LIDS NOT INCLUDED



SIZE	PRODUCT CODE	QTY/BOX	PRICE	CAP CODE
380 ml	BOT380	12	\$0.91	CAPHC7, CAPWF7, CAPPC7, 728470
780 ml	BOT780	12	\$1.16	CAPHC8, CAPWF8, CAPPC8, CAPG82

Very competitive skid pricing.
Call your local CDL store for details.

METAL LIDS



38 mm	728438	\$0.10
48 mm	72843000	\$0.15
53 mm	CAPG53	\$0.18
58 mm	788490	\$0.19
63 mm	788470	\$0.20
70 mm	728470	\$0.21
82 mm	CAPG82	\$0.29

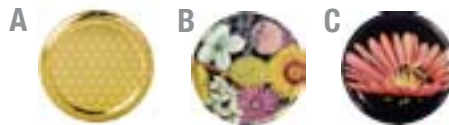

	70 mm	CAPHC7	\$0.25
A	82 mm	CAPHC8	\$0.29
	70 mm	CAPWF7	\$0.29
B	82 mm	CAPWF8	\$0.33
	70 mm	CAPPC7	\$0.33
C	82 mm	CAPPC8	\$0.37

SAMPLE JARS



30 ml jars	EICOL016	\$0.89
Cap only	EXBSCAP16	\$0.12

BOTTLES AND PACKAGING

PLASTIC JUGS



CAPS INCLUDED

SIZE	PRODUCT CODE	QTY/BOX	PRICE PER UNIT	PRICE PER UNIT SOLD BY CASE
40 ml	728140040	100	\$0.94	\$0.82
100 ml	72814100	100	\$1.02	\$0.87
250 ml	72814250	100	\$1.15	\$0.99
500 ml	72814500	100	\$1.30	\$1.03
1 L	72814001	100	\$1.55	\$1.23
2 L	66925	50	\$1.89	\$1.60
4 L	72814004	24	\$2.65	\$2.14



SIZE	PRODUCT CODE	QTY/BOX	PRICE PER UNIT	PRICE PER UNIT SOLD BY CASE
40 ml	EXCR0041O	100	\$1.04	\$0.92
100 ml	EXCR0101O	100	\$1.12	\$0.97
250 ml	EXCR0261O	100	\$1.25	\$1.09
500 ml	EXCR0501O	100	\$1.40	\$1.13
1 L	EXCR1001O	100	\$1.65	\$1.33
2 L	EXCR2001O	50	\$1.99	\$1.70
4 L	EXCR4001O	24	\$2.75	\$2.24

Caps included



SIZE	PRODUCT CODE	QTY/BOX	PRICE PER UNIT	PRICE PER UNIT SOLD BY CASE
1.36 oz	EXCR0041*	100	\$0.97	\$0.85
3.4 oz	EXCR0101*	100	\$1.07	\$0.92
½ pint	EXCR0261*	100	\$1.20	\$1.04
1 pint	EXCR0501*	100	\$1.34	\$1.07
1 quart	EXCR1001*	100	\$1.62	\$1.30
½ gallon	EXCR2001*	50	\$1.99	\$1.70
1 gallon	EXCR4001*	24	\$2.73	\$2.22

For specific states, replace the * by:

- | | |
|----------------------|----------------------|
| U for All States | MI for Michigan |
| V for Vermont | P for Pennsylvania |
| N for New York | IN for Indiana |
| NH for New Hampshire | WV for West Virginia |
| ME for Maine | MA for Massachusetts |
| WI for Wisconsin | OH for Ohio |

Very competitive skid pricing.
Call your local CDL store for details.

EXTRA JUG CAPS



BROWN PLASTIC CAPS FOR JUGS

100 ml cap for jugs	6628401	\$0.20
250 ml to 4 L cap for jugs	6628400	\$0.23

BOTTLES AND PACKAGING

PLASTIC BOTTLES



A



B



C



D



E



F



G



	DESCRIPTION	SIZE	PRODUCT CODE	QTY/BOX	PRICE PER UNIT
A	Oxygen barrier bottle	375 ml	660375	200	\$0.80
B	Oxygen barrier bottle	500 ml	661500	150	\$0.88
C	Oxygen barrier bottle	1 L	661000	90	\$1.30
D	Oxygen barrier bottle	2 L	660020	6	\$2.55
E	Oxygen barrier bottle	4 L	660400	40	\$4.10
F	Freezer jug	4 L	EXSH4P	56	\$1.35
G	Plastic jug	10 L	JUG210	1	\$5.48

EXTRA CAPS FOR OXYGEN BARRIER BOTTLES AND FREEZER JUG

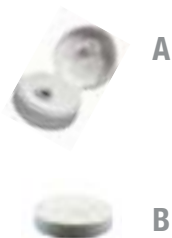

A

B

	DESCRIPTION	SIZE	PRODUCT CODE	PRICE PER UNIT
A	Bottle cap 375 ml, 500 ml	-	661375	\$0.20
B	Bottle cap 1 L, 2 L, 4 L	53 x 400 mm	661380	\$0.23
	Freezer jug cap	38 x 400 mm	661381	\$0.10
	Cap for JUG210	-	CAP10L	\$0.25

CARDBOARD BOXES FOR PLASTIC BOTTLES



	DESCRIPTION	SIZE	PRODUCT CODE	PRICE PER UNIT
	Cardboard box with handle	8 x 375 ml	668375	\$0.70
	Cardboard box with handle	8 x 500 ml	664350	\$0.95
	Cardboard box	12 x 375 ml	612375	\$0.91

BOTTLES AND PACKAGING

PLASTIC CONTAINERS



**High definition printing
and superior quality**

With security seal

NEW

DESCRIPTION	PRODUCT CODE	PRICE
250 g Lock container, Maple taffy, 500/box	60256	\$0.48/un.
250 g Lock container, Maple cream, 500/box	60255	\$0.48/un.



250 g container
500/box
60250

\$0.51/ea

250 ml colonial container
100/box



U.S.A Seulement
EXCUL251U

\$1.30/ea

500 ml colonial container
100/box

U.S.A Seulement
EXCUL501U

\$1.65/ea

Beige plastic container
for maple cream
250 g, 100/box



TUBB25

\$1.49/ea

Beige plastic container for
maple cream
500 g, 100/box

TUBB50

\$1.89/ea

Clear plastic container
(Lid not included)
100g P325 | 250/pkg

6603905

\$12.95

Clear plastic lid for P325 |
125/pkg
6603906



\$4.95



500 g container
500/box
62500

\$0.60/ea



250 g organic container
500/box
Organic certificate required
60250B

\$0.53/ea



300 g Surlock container
350/box
622514

\$0.50/ea



300 g square container
Clear
700/box
60251

\$0.53/ea

PLASTIC CONTAINERS



DESCRIPTION	PRODUCT CODE	PRICE
4 oz. granulated sugar container	EXPLSUG4	\$0.79
8 oz. granulated sugar container	EXPLSUG8	\$0.99

BOTTLES AND PACKAGING

SELF-ADHESIVE LABELS

A



B



C



D



E



	DESCRIPTION	PRODUCT CODE	DIMENSION	QTY/ROLL	PRICE
A	Nutrition facts	660253		200	\$12.60
	Nutrition facts	NFME25		250	\$14.25
	Nutrition facts	NFLA25		250	\$16.30
	Nutrition facts	NFMB25		250	\$14.25
	Nutrition facts	NFSM25		250	\$14.25
B	375 ml	660201		200	\$8.80
	500 ml	660202		200	\$8.80
	1 L	660251		100	\$12.30
	2 L	660252		100	\$12.30
	4 L	660254		100	\$12.30
C		MAPBUT	1-3/8" H x 3 1/2" L	250	\$21.40
D		BAGHEA	2" H x 3 1/2" L	250	\$25.70
E	Oval 250 ml	LABB25	1 3/4" H x 3" L	250	\$25.70
	Oval None	LABBSB	1 3/4" H x 3" L	250	\$25.70
	Oval 500 ml	LABB50	2 1/2" H x 4" L	250	\$25.70
	Oval None	LABBLB	2 1/2" H x 4" L	250	\$25.70
	Oval 1 L	LABB01	2 1/2" H x 4" L	250	\$25.70
F	White rectangle	LABOSB	2 3/4" H x 1-7/8" L	250	\$25.70
	White oval	LABOLO	4 5/16" H x 3 3/16" L	250	\$25.70
	White rectangle	LABOLB	3 1/2" H x 2 1/2" L	250	\$25.70
G	None	LABBRB	2 1/2" H x 2 1/2" L	250	\$25.70
H	None	LABNSB	2 1/2" H x 2-1/8" L	250	\$25.70
	250 ml	LABN25	2 1/2" H x 2 1/8" L	250	\$25.70
	Aucun	LABNLB	3 5/8" H x 2 3/4" L	250	\$25.70
	500 ml	LABN50	3 5/8" H x 2 3/4" L	250	\$25.70
	1L	LABN01	3 5/8" H x 2 3/4" L	250	\$25.70

F



G



H

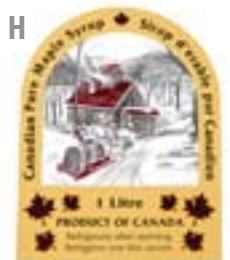

BOTTLES AND PACKAGING

SELF-ADHESIVE LABELS



DESCRIPTION	CONTAINS	PRODUCT CODE	QTY/PKG	PRICE
Pure maple syrup	250 ml	EXLA0250	100	\$11.75
Pure maple syrup	350 ml	EXLA0375	100	\$11.75
Pure maple syrup	Small	660201P	100	\$11.75
Pure maple syrup	500 ml	EXLA0500	100	\$13.25
Pure maple syrup	Large	EXLA0500P	100	\$13.25

SYRUP GRADING SELF-ADHESIVE LABELS



DESCRIPTION	PRODUCT CODE	QTY/PKG	PRICE/PKG
Canada Golden	660260	500	\$9.15
Canada Amber	660262	500	\$9.15
Canada Dark	660258	500	\$9.15
Canada Very Dark	660259	500	\$9.15
Canada No.1 Extra Light	GRAGEX	500	\$8.50
Canada No.1 Light	GRAGLI	500	\$8.50
Canada No.1 Medium	GRAGME	500	\$8.50
Canada No.2 Amber	GRAGAM	500	\$8.50
Québec Golden	660226	250	\$8.95
Québec Amber	660227	250	\$8.95
Québec dark	660228	250	\$8.95
Québec Very dark	660229	250	\$8.95
Ontario Golden	660230	500	\$8.95
Ontario Amber	660231	500	\$8.95
Ontario Dark	660232	500	\$8.95
Ontario Very dark	660233	500	\$8.95
Vermont Quality	EXECVT01	1000	\$7.15
Vermont Golden	EXLAVTG	1000	\$7.40
Vermont Amber	EXLAVTA	1000	\$7.40
Vermont Dark	EXLAVTD	1000	\$7.40
Vermont Very dark	EXLAVTV	1000	\$7.40
New York Golden	EXLANYG	1000	\$7.40
New York Amber	EXLANYA	1000	\$7.40
New York Dark	EXLANYD	1000	\$7.40
New York Very Dark	EXLANYVD	1000	\$7.40
Maine Golden	EXLAMEG	1000	\$7.40
Maine Amber	EXLAMEA	1000	\$7.40
Maine Dark	EXLAMED	1000	\$7.40
Maine Very Dark	EXLAMEV	1000	\$7.40
US Golden	EXLAUSG	1000	\$7.40
US Amber	EXLAUSA	1000	\$7.40
US Dark	EXLAUSD	1000	\$7.40
US Very Dark	EXLAUSB	1000	\$7.40

BOTTLES AND PACKAGING

SECURITY SEALS



250/roll	TAMEVI	\$15.60
500/roll	TAMEVI500	\$30.95

HANG TAGS AND ELASTICS



	DESCRIPTION	PRODUCT CODE	QTY/PKG	PRICE/PKG
A	Hang tag	HANTAG	100	\$25.70
B	50 ml Hang tag	EXEC0050	250	\$20.40
	200 ml Hang tag	EXEC0200	250	\$20.40
	250 ml Hang tag	EXEC0250	250	\$20.40
	500 ml Hang tag	EXEC0500	250	\$20.40
	Hang tag	EXECPLAIN	250	\$20.40
C	Hang tag	NECBRO	100	\$8.50
D	Golden elastic	EXECMEL6G	100	\$15.30

SIGNS AND FLAGS



	DESCRIPTION	PRODUCT CODE	PRICE
A	9" x 13" cardboard sign	ECMS0913	\$4.85
B	24" x 36" metal sign	ECMS2436	\$66.30
	10" X 14" plastic sign	ECMP1014	\$20.35
	24" X 36" plastic sign	ECMP2436	\$55.00
C	20" x 30" plastic sign	SIGNGR	\$19.30
D	18" x 24" coroplast sign	SIGNYE	\$19.30
E	20" x 30"	SIGNAM	\$19.30
F	20" x 30" plastic sign	SIGNBL	\$19.30
G	Flag	663660	\$40.75

PROMOTIONAL ITEMS



DESCRIPTION	PRODUCT CODE	PRICE
Cooking apron	890001	\$18.95



BOTTLES AND PACKAGING

WOODEN STICKS



Medium wooden sticks
pkg 12
668911 \$15.25

18" wooden sticks
pkg 12
66891 \$19.95



6" taffy sticks
pkg 500
72925050 \$10.95

GLUCOSE AND POWDER GENUGEL



2,25 kg
For the hardness of sweets and lollipops
6680801 \$11.95

25 kg
For the hardness of sweets and lollipops
66808 \$84.95



200 g
For the hardness of sweets and lollipops
72926170 \$19.95

CONES, BOXES AND SUPPORTS



72/box
66137 \$4.99

900/box
66138 \$28.50



6 holes
ECBCOR06 \$0.75

12 holes
ECBCOR12 \$0.80



CDL wooden support
for cones
14 holes
666314 \$24.95

MAPLE TEA



Tea
ECMAPTU \$5.25

Herbal tea
ECMAPTI \$5.25

CANDY BOXES



12 cavities, 4½" X 6"
60115 \$0.59

25 cavities, 4½" X 9"
60128 \$0.68



One bite candy box
60101 \$0.32



1" brown paper cups
pkg 1 000
EXBB0251 \$6.95



6 cavities, 3 ½" X 4 5/8"
60127 \$0.85

7" X 4" X 1"
60131 \$0.95



Two bite candy box
60102 \$0.42



1¾" white paper cups
pkg 1 000
EXBB0101 \$8.25

BOTTLES AND PACKAGING

HARD CANDY MOLDS

DESCRIPTION	CAVITY/QTY	PRODUCT CODE	PRICE
Assorted designs	20	ECMS3057	\$4.40
Christmas trees	20	ECMSH196	\$4.40
Flowers, fruits, nuts	25	ECMSH479	\$4.40
Hearts	14	ECMSH599	\$4.40
Small hearts	18	ECMS0204	\$4.40
Maple leaves	12	ECMS3185	\$4.40
Rectangles	20	ECMS3029	\$4.40
Stars	20	ECMSH227	\$4.40
Strawberries	12	ECMSH150	\$4.40



RUBBER CANDY MOLDS



DESCRIPTION	CAVITY/QTY	PRODUCT CODE	PRICE
Christmas trees	20	ECMC1148	\$30.50
Snowmen	20	ECMC1473	\$30.50
Sugar shacks	14	ECMC1165	\$30.50
Cats	40	ECMC1382	\$30.50
Bells	160	ECMC1401	\$107.00
Double hearts	50	ECMC0F42	\$39.95
Small hearts	42	ECMC0119	\$30.50
Big hearts	15	ECMC1056	\$30.50
Stars	20	ECMC1151	\$30.50
Ghosts	20	ECMC1516	\$30.50
Maple leaves	20	ECMC1243	\$30.50
Maple leaves	160	ECMC1301	\$107.00
Maple leaves	240	ECMC1292	\$107.00
Maple leaves	72	ECMC1204	\$107.00
Maple leaves	12	ECMC1138	\$30.50
Maple leaves	8	ECMC1137	\$30.50
Fleurs-de-lis	20	ECMC1270	\$30.50
Snow flakes	20	ECMC1477	\$30.50
Fruits and flowers	105	ECMC0011	\$107.00
Mixed fruits	77	ECMCA041	\$107.00

DESCRIPTION	CAVITY/QTY	PRODUCT CODE	PRICE
Owls	16	ECMC1480	\$30.50
Rabbits	36	ECMC1384	\$107.00
Rabbits	160	ECMC1360	\$107.00
Small rabbits	7	ECMC1136	\$30.50
Big rabbits	4	ECMC1135	\$30.50
Daisies	63	ECMC0069	\$30.50
Assorted designs	160	ECMC0830	\$112.00
Assorted Christmas	80	ECMC1451	\$107.00
Moose	6	ECMC0006	\$30.50
Butterflies	20	ECMC1483	\$30.50
Santa Clauses	10	ECMC1133	\$30.50
Santa Clauses	20	ECMC1150	\$30.50
Small women	80	ECMC1233A	\$107.00
Small mermaids	20	ECMC1233	\$30.50
Small men	80	ECMC1162	\$107.00
Small bears	12	ECMC1398A	\$30.50
Chicken	160	ECMC1159	\$107.00
Wooden buckets	16	ECMC1236	\$30.50
Indian heads	6	ECMC1176	\$30.50

CHOCOLATE MOLDS



DESCRIPTION	CAVITY/QTY	PRODUCT CODE	PRICE
Squares	20	EMCC071	\$4.85
Maple leaves	12	EMCC0121	\$4.85
Fleurs-de-lis (squares)	12	EMCC079	\$4.85
Snow flakes	9	EMCC039	\$4.85
Assorted designs	12	EMCC055	\$4.85
Ovals	12	EMCC035	\$4.85
Pyramids	12	EMCC129	\$4.85
Rounds	12	EMCC070	\$4.85
Farm animals (for suckers)	4	EMCS11219	\$4.85

SUCKER CANDY MOLDS



DESCRIPTION	CAVITY/QTY	PRODUCT CODE	PRICE
Barrels	7	ECMS3205	\$4.40
Baseballs	6	ECMS3043	\$4.40
Snowmen	6	ECMSH404	\$4.40
Hearts	6	ECMSH324	\$4.40
Elephants	5	ECMS0572	\$4.40
Maple leaves	6	ECMS3450	\$4.40
Frogs	5	ECMS3303	\$4.40
Rabbits (female)	5	ECMSH254	\$4.40
Daisies	3	ECMS0866	\$4.40
Skates	4	ECMS6250	\$4.40
Apples	6	ECMS3190	\$4.40
Rounds	3	ECMS0573	\$4.40
Smiles (big)	4	ECMSH962	\$4.40
Smiles (small)	6	ECMSH961	\$4.40
Santa Claus heads	6	ECMSG214	\$4.40
Tractors	4	ECMS1219	\$4.40

SUCKER BAGS AND STICKS



DESCRIPTION	DIMENSIONS	QTY/PKG	PRODUCT CODE	PRICE/PKG
Cellophane bags	4¾" x 6¾"	100	ECMSC406	\$6.90
Cellophane bags	3" x 4"	100	ECMSC304	\$4.05
Plastic bags	3" x 5"	100	ECMSS305	\$2.30
Plastic bags	4" x 5"	100	ECMSS405	\$2.55
Sticks	3¾"	1000	ECMSB375	\$17.30
Sticks	4½"	1000	ECMSB450	\$19.65

DISPENSER



Tape dispenser
661150 \$19.25



9 mm x 165 m tape
661151 \$4.45

BOOKS



The Maple Syrup Book

A book that celebrates the human aspect of maple syrup production from yesterday to today.

TMSBOO \$24.95



A Guide To Improving and Maintaining Sugar Bush Health and Productivity

This book provides guidelines that help maple producers improve and maintain the productivity of their sugar bush.

BOOSBH \$24.95



Design, Installation and Maintenance of Plastic Tubing Systems for Sap Collection in Sugar Bushes

This manual includes detailed information on the design, installation and maintenance of sap collection systems.

BOODIM \$19.95



Bigleaf Sugaring, Tapping the Western Maple

A practical guide to bottling in order to obtain a quality product.

BIGSUG \$16.95



The Birch Syrup Production Manual

An informative manual for those interested in the production of birch syrup.

BIRMAN \$39.95



Backyard Sugarin'

An excellent guide for people who would like to start producing maple syrup for pleasure or personal enrichment.

ECBYSMAN4 \$16.95



Maple Sugar

ECMAPLE \$12.95



The Sugarmaker's Companion

This guide is the first of its kind, addressing the small and big syrup producer who is looking to have a profitable business out of maple, birch and nut sap.

SUGCOM \$45.95



Farmstead Favourites: Maple Syrup Cookbook

Over 75 proposed recipes made from fresh farm produce.

FARFAV \$10.50



The Maple Syrup Cookbook

Offers recipes for breakfasts, appetizers, beverages, pastries and desserts.

ECCBOOK2 \$14.95



Vermont Cookbook

Cookbook.

ECCBOOKVT \$14.95



DVD "The Sweetest Drip" Making of Maple Syrup

Maple syrup making DVD.

ECDVD01 \$34.95



OMSPA "Sweet Ontario"

Recipe book.

662505 \$15.00



Sugarhouse Coloring Book

Coloring book.

ECSUGCOLOR \$1.60

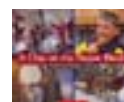

A Day At The Sugarbush

Book includes colorful images and simple texts for young readers. Ideal for children from 4 to 8 years old.

DAYSUG \$7.95



At Grandpa's Sugar Bush

Illustrated history book on the making of maple syrup and annual traditions. For children from 3 to 8 years.

SUGBSC \$6.95



The Sugaring-Off Party

A French Canadian grandmother remembers her first sugar party, music, dance and lots of food. For children from 4 to 8 years old.

SUGOSC \$10.95

CORPRATE STORES,
DISTRIBUTORS
AND REPRESENTATIVES

CONTACT

US

With 29 corporate stores, more than 40 distributors and over 50 representatives covering Quebec, Ontario, the Maritimes and all the Northeastern United States, CDL is a real force in the world of maple syrup.

Meet with you, listen and give advice are some of the tasks we enjoy most. Can't wait to see you!

CORPORATE STORES, DISTRIBUTORS AND REPRESENTATIVES QUEBEC

CORPORATE STORES

Les équipements d'érablière CDL inc.

257, route 279
Saint-Lazare (QC) G0R 3J0
P. 418-883-5158 F. 418-883-4159
Toll free. 1-800-361-5158
cdlst-lazare@cdlinc.ca

Head Office

CDL Beauce

776, 8^e rue
La Guadeloupe (QC) G0M 1G0
P. 418-459-6218 F. 418-459-3210
P. 1-800-459-6218
cdlbeauce@cdlinc.ca

CDL Cabano

315, boulevard Industriel
Témiscouata-sur-le-Lac (QC) G0L 1E0
P. 418-854-5158 F. 418-854-1118
Toll free. 1-877-854-5158
cdlcabano@cdlinc.ca

CDL Haut-St-Laurent

2535, Route 209
Saint-Antoine-Abbé (QC) J0S 1N0
P. 1-844-805-1235 F. 1-844-805-1675
cdlhautst-laurent@cdlinc.ca

CDL L'Islet

194, route 204
Saint-Adalbert (QC) G0R 2M0
P. 418-356-5153 F. 418-356-5153
cdllislet@cdlinc.ca

CDL Portneuf

1142, avenue St-Louis
Portneuf (QC) G0A 2Y0
P. 418-286-0003 F. 418-286-0151
cdlportneuf@cdlinc.ca

CDL Sawyerville

143, rue de Cookshire
Sawyerville (QC) J0B 3A0
P. 819-416-1505 F. 819-416-1501
cdlsawyerville@cdlinc.ca

CDL Shefford

2981, route 112
Shefford (QC) J2M 1C6
P. 450-539-2225 F. 450-539-0500
cdlshefford@cdlinc.ca

CDL Sainte-Auréli

Équipements d'érablière Guy Maheux inc.

8, rang Saint-Jean-Baptiste
Sainte-Auréli (QC) G0M 1M0
P. 418-593-3804 P. 418-593-3805
F. 418-593-3804
cdlste-aurelie@cdlinc.ca

CDL Thetford

1892, rue Nadeau, Thetford Mines
Secteur Pontbriand (QC) G6H 3K3
P. 418-335-0853 F. 418-335-3745
cdlthetford@cdlinc.ca

CDL Warwick

1, route 116 Est
Warwick(QC) J0A 1M0
P. 819-358-3950 F. 819-358-3959
cdlwarwick@cdlinc.ca

DISTRIBUTORS

01- BAS-SAINT-LAURENT

Magasin Général L.G, Thibault

Bas-Saint-Laurent (Ouest)
6123, de l'Église
Saint-Athanase (QC) G0L 2L0
P. 418-859-2171 F. 418-859-3045

14-LANAUDIÈRE

Agri-Service D.M.R. inc.

Lanaudière
4011, rue Principale
Saint-Félix-de-Valois (QC) J0K 2M0
P. 450-889-8341 F. 450-889-2305
Toll free. 1-800-667-7030

17-CENTRE-DU-QUÉBEC

E. Côté & fils inc.

Asbestos
286, rue Notre-Dame
Roxton Falls (QC) J0H 1E0
P. 450-548-2242 F. 450-548-2481

12-CHAUDIÈRES-APPALACHES

Bernard Rodrigue et Cathy Maheux

Beauce (Est)
195, boulevard Lessard
Sainte-Justine (QC) G0R 1Y0
P. 418-383-3369 F. 418-383-3368
bernard.rodrigue@cdlinc.ca

15-LAURENTIDES

Meuneries Mondou

Laurentides
12429, route Arthur-Sauvé
Mirabel (QC) J7N 2C2
P. 450-258-2817 F. 450-258-4626
Toll free. 1-888-258-2817
groupemondou@meuneriemondou.com

Les Moulins B.G.L. inc.

Laurentides
14, rue Legault
St-André-d'Argenteuil (QC) J0V 1X0
P. 450-537-3774 F. 450-537-3777



CORPORATE STORES, DISTRIBUTORS AND REPRESENTATIVES QUEBEC

REPRESENTATIVES

Claude Fecteau

Baie des Chaleurs, Gaspésie (Sud),
Nouveau-Brunswick (Nord-Est)
claude.fecteau@cdlinc.ca
c. 418-865-3512 P. 418-865-4609

Daniel Bélanger

Gaspésie (Nord) La Mitis, Matapédia,
MRC de Matane
daniel.belanger@cdlinc.ca
c. 418-629-0639 P. 418-629-5652

Daniel Guay

Mauricie, Portneuf
daniel.guay@cdlinc.ca
c. 418-286-0003

Germain Fortin

Estrie
germain.fortin@cdlinc.ca
c. 450-525-2232

Ghislain Poulin

Beauce (Ouest)
ghislain.poulin@cdlinc.ca
c. 418-222-7502

Guy Breault

Lanaudière et Laurentides
guy.breault@cdlinc.ca
c. 450-916-7805 P. 450-834-6454

Guy Maheux

Beauce (Est)
guy.maheux@cdlinc.ca
guym@sogetel.net
c. 418-226-7803
P. 418-593-3804 P. 418-593-3805
F. 418-593-3804

Jacques St-Pierre

Bas-St-Laurent (Ouest),
Nouveau-Brunswick (Nord-Ouest)
jacques.st-pierre@cdlinc.ca
c. 418-860-7447

Jocelyn Dumont

Asbestos, Drummondville,
MRC d'Arthabaska, Nicolet, St-Hyacinthe
jocelyn.dumont@cdlinc.ca
c. 819-350-8383

Jocelyn Pouliot

Beauce (Sud)
jocelyn.pouliot@cdlinc.ca
c. 418-222-7623

Loïc Plante

Mégantic-Estrie
loic.plante@cdlinc.ca
c. 819-578-9890

Marc Frongillo

Coaticook
marc.frongillo@cdlinc.ca
c. 819-578-8839 P. 819-416-1505

Serge Fortier

Beauce (Nord), Bellechasse (Ouest)
serge.fortier@cdlinc.ca
c. 418-883-5594 P. 418-642-2636

Serge Valiquette

Haute-Laurentides, Outaouais
serge.valiquette@cdlinc.ca
c. 514-249-7301 P. 450-267-0447

Stéphane Pelletier

Kamouraska, L'Islet, Montmagny
stephane.pelletier@cdlinc.ca
c. 418-356-6100 P. 418-359-2200

Yan Gaudet

Temiscamingue
yan.gaudet@cdlinc.ca
c. 819-629-4157

Yvan Bourdeau

Montérégie (Ouest), Valleyfield
yvan.gaudet@cdlinc.ca
c. 819-629-4157

Marco Sheink

Bas-St-Laurent (Est)
marco.sheink@cdlinc.ca
c. 581-337-2922 P. 418-779-2922
Pagette: 418-867-0117

Pierre-Simon Morin

Bellechasse (Sud)
pierre.simon.morin@cdlinc.ca
c. 418-573-7011

Nicolas Larochelle

Bellechasse (Nord), Ile d'Orléans
et Côte-de-Beaupré
nicolas.larochelle@cdlinc.ca
c. 418-580-1082

Éric Guay

Beauce (Est)
eric.guay@cdlinc.ca
c. 418-222-7300 F. 418-593-3804
P. 418-593-3804 P. 418-593-3805

Yannic Lataille

Lotbinière et l'Érable Sud
yannic.lataille@cdlinc.ca
c. 581-985-6550 P. 418-801-9057

Michaël Cyr

Amiante et l'Érable Sud
michael.cyr@cdlinc.ca
c. 581-991-3645

Mario Côté

Roxton Falls
mario.cote@cdlinc.ca
c. 450-777-9712 P. 450-548-2242

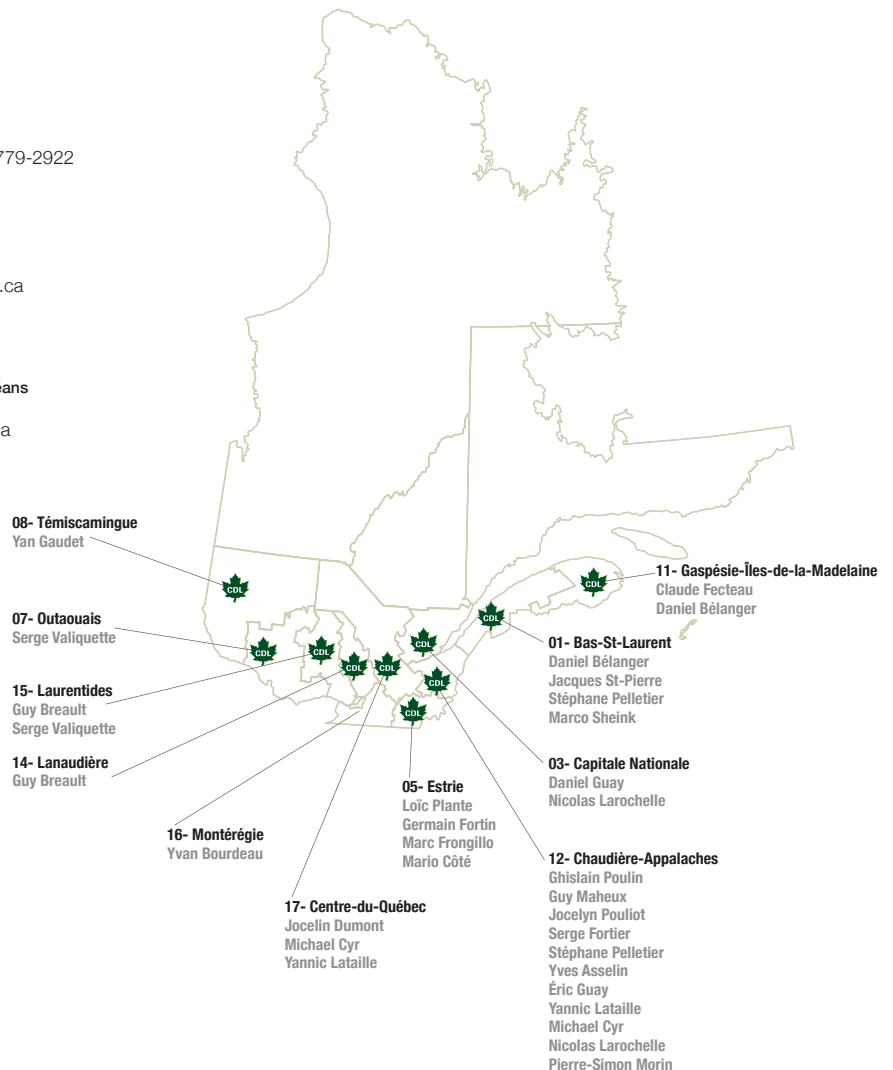

CORPORATE STORES, DISTRIBUTORS AND REPRESENTATIVES UNITED STATES

CORPORATE STORES

CDL St.Albans

3 Lemnah Drive
SP, Albans, VT 05478
P. 802-527-0000 F. 802-524-3666
Toll free. 1-800-762-5587
stalbans@cdlusa.net
www.cdlusa.net

Head Office

CDL Morrisville

559 Harrel Street
Morrisville, VT 05661
P. 802-851-8232 F. 802-851-8153
morrisville@cdlusa.net

CDL Northeast Kingdom

The Pick N' Shovel
54 Conventry Street
Newport, VT 05855
P. 802-334-8370 F. 802-334-1218
pick.maple@comcast.net

CDL Western New York

5760 State Route 19A
Castile, NY 14427
P. 585-493-5102 F. 585-493-5105
wny@cdlusa.net

CDL Pennsylvania

91 Patterson Road
Westfield, PA 16950
P. 814-628-2082 F. 814-628-2084
Toll free. 1-855-501-2771
pa@cdlusa.net

CDL Ohio

Roger Gortner
1244, township Road 13
West Salem, OH 44287
P. 419-651-6334 c. 419-651-2425
ohio@cdlusa.net

CDL Wisconsin

Roth Sugar Bush
Peter and Dawn Roth
656 Tower Drive County Hwy EE
Cadott, WI 54727
P. 715-289-3820 F. 715-289-3821
info@rothsugarbush.com
www.rothsugarbush

CDL Michigan

RMG Family Sugar Bush
11866 W Thompson Rd
Rudyard, MI 49780
P. 906-478-3038 F. 906-478-7830
Toll free. 1-800-50MAPLE (506-2753)
c. 906-322-0765
mjross@lighthouse.net
www.rmgmaple.com

CDL Rutland

1867 US RT 7
Pittsford, VT 05763
P. 802-725-8040 F. 802-725-8097
rutland@cdlusa.net

CDL Maine

319 US Route 2E
Wilton, ME 04294
P. 207-645-4000 F. 207-645-4003
maine@cdlusa.net

CDL Enosburg

257 Pearl Street
Enosburg Falls, VT 05450
P. 802-933-4279 F. 802-933-6908
enosburg@cdlusa.net

CDL North East NY

1036, Slosson Road
West Chazy, NY 12992
P. 518-493-3043 F. 518-493-2153
neny@cdlusa.net

REPRESENTATIVES

Tim Eldridge
Northern Pennsylvania
c. 814-367-7811

Gordy Putnam
Western New York
c. 585-322-5507

Miguel Ibarguen
Maine
c. 207-578-0411

Roger Gortner
Ohio
c. 419-651-2425

Zel Larivee
Franklin County, VT
c. 802-933-4279

Mike Lynch
Southern PA
c. 814-442-3680

Mike Parker
North East NY
c. 518-420-4497

Garth Atherton
All States (Monitoring)
c. 802-309-8938

Scott Boyce
VT (Northeast Kingdom), IN ,WV, IL,
c. 802-782-6150

Nick Atherton
Vermont (Franklin County)
c. 802-309-9610

David Allen
Vermont (Southern Chittenden, Western
Addison County)
c. 802-734-1105

Ben Shepard
Orange, SO, Washington, SE Addison,
SO, Caledonia County, VT
c. 802-373-2799

Fred Ahrens
Ohio
c. 330-206-1606

Tom Patterson
ME, RI, MA, CT, NH
c. 802-782-2450

Tim Bockus
New York
c. 802-309-8847

Mitchell Charron
In House SP, Albans, VT
Storecell. 802-393-9092

James Adamski
WI, IA, MI
c. 715-216-7855

Rick Marsh
Vermont (Lamoille County, Chittenden,
Washington County)
c. 802-730-4604

Reg Charbonneau
Southern VT, MA, CT, Southern NH
c. 802-236-3452

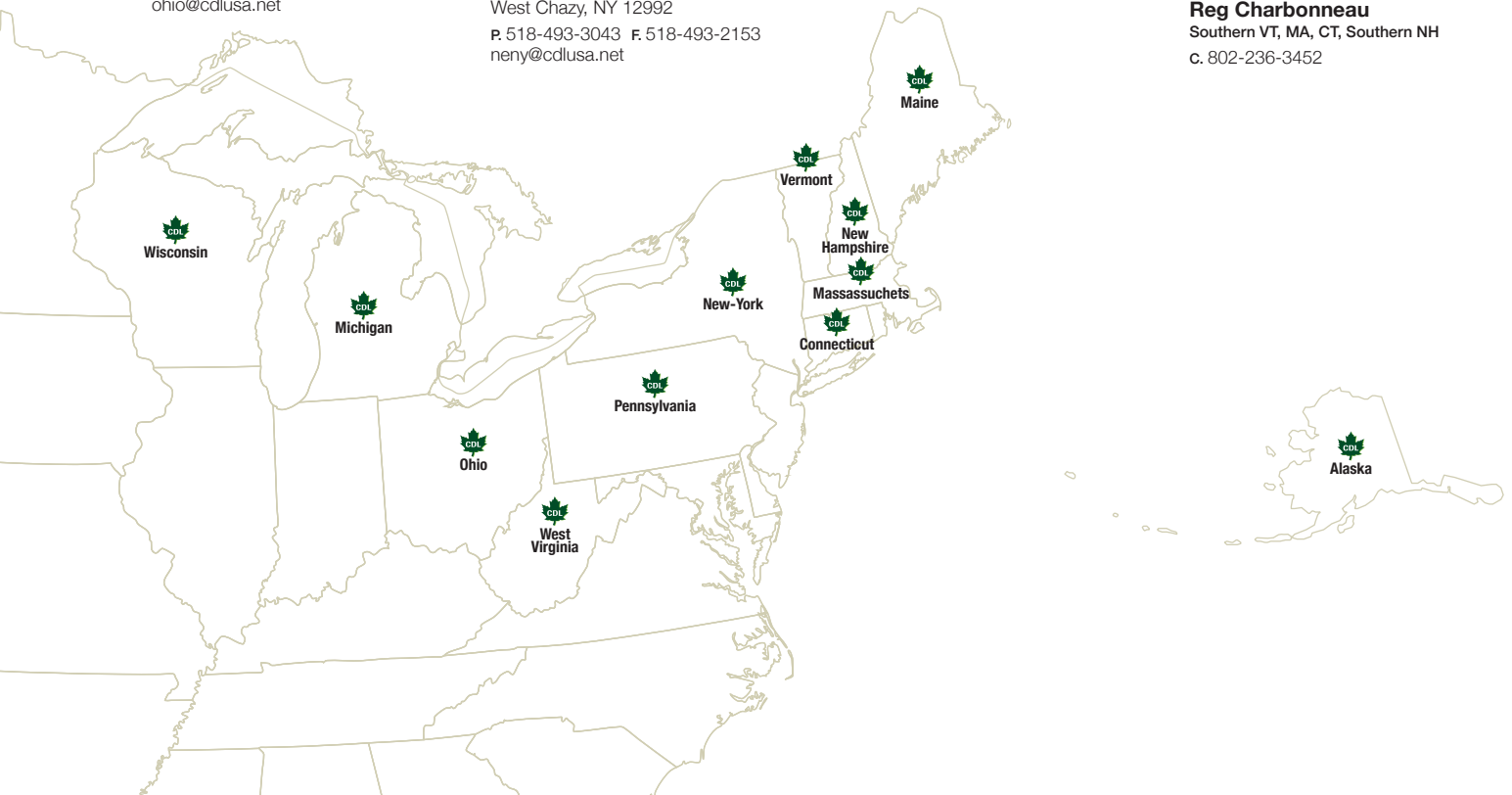

CORPORATE STORES, DISTRIBUTORS AND REPRESENTATIVES UNITED STATES

DISTRIBUTORS

ALASKA

Mike and Dulce East

Kahlitna Birchworks
5400 East Revolutionary Way
Wasilla, Alaska 99654
P. 907-373-1309 F. 907-373-1359
michael@alaskabirchsyrop.com

CONNECTICUT

Lamothe's Sugar House

Robert & Jean Lamothe
89 Stone Road, Burlington, CT 06013
P. 860-675-5043
www.lamothesugarhouse.com
lamothes.sugar.house@snet.net

INDIANA

Sweet Beginnings Maple

Silas Beachler
9569 South 600 East, Claypool,
IN 46510
P. 260-578-1625
silasjay90@yahoo.com

MAINE

Slattery's Farm & Maple Supply Co.

Wayne & Joni Slattery
1381 Woodman Hill Road P.O. Box 94
West Minot, ME 04288
P. 207-966-3643
slatbake2001@yahoo.com

Lyle & Jo Ann Merrifield

195 North Gorham Road,
Gorham, ME 04038
P. 207-892-5061 C. 207-415-3001
merfarm@aol.com

MASSACHUSETTS

Keith A. Dufresne

113 Goshen Road,
Williamsburg, MA 01096
P. 413-268-7509 F. 206-202-2027
sugarmaker@msn.com

MINNESOTA

Don's Sugar Shack

842 West Street, Taylor Falls MN 55084
P. 612-201-1086

Tim Woodrow

31776 416th ave, Aitken, MN 56431
P. 218-831-6799

NEW HAMPSHIRE

Bascom Maple Farms

Bruce Bascom
56 Sugar House Road,
Alstead, NH 03602
P. 603-835-6361 F. 603-835-2455
sales@bascommaple.com

D & D Maple

Dave Kemp
5 Sawmill Drive, Jaffrey, NH 03452
P. 603-532-8496 C. 603-562-6973
david.kemp7@myfairpoint.net

Hicks Hardware

120 Main Street, Colebrook, NH 03576
P. 603-237-5531 F. 603-237-4190

Sunnyside Maples Inc

Mike Moore
554 Meadow Pond Road
Gilmanton, NH 03237
P. 603-267-8217 F. 603-267-6457
C. 603-848-7091
sugarmaker@aol.com

NEW YORK

Dominic's Hardware Supplies

Jim Dominic
5195 State Route 11
Ellenburg Depot, NY 12935
P. 518-594-3922 F. 518-594-7786
lynn@dominicshardware.com

Grottoli's Maple Farm

91 Ritchie Road,
Middle Granville, NY 12849
P. 518-642-2856 C. 518-796-8469
grottolimapple@yahoo.com

Catskill Mountain Maple

Thomas Kaufman
65 Charlie Wood Maple,
Delancey, NY 13752
P. 607-746-6215 F. 607-746-8367
tomshane95@msn.com

Moser's Maple Ridge Farm

Lyndon Moser
3981 Wilson Road,
Copenhagen, NY 13626
P. 315-688-2518 C. 315-486-3248
mosersmapleridgefarm@gmail.com

Mill Creek Maple Supply

David Norton
1551 Cty Hwy 20,
Edmeston, NY 13335
P. 607-965-6920 F. 607-965-6921
millcreekmaple@yahoo.com

Mike Bennett

82 Mc Donald Street,
Glens Falls, NY 12801
P. 518-222-4990

Dick Dunn

373 Hunt Hill Road,
Ithaca, NY 14850
P. 607-539-6515 C. 607-342-1452

Woody's Maple Supplies

James Woodrow
418 Underwood Road,
Hermon, NY 13652
P. 315-347-2395 C. 315-783-8148
jjaw@tds.net

OHIO

Sugarbush Creek

Jim Cermak
13034 Madison Road,
Middlefield, OH 44062
P. 440-636-5371 F. 216-381-3401

Williams Maple Products

Joshua Williams
Canal Winchester, OH 43110
P. 614-920-1935 F. 419-239-6764
williamsmapleproducts@gmail.com

PENNSYLVANIA

Brenneman's Maple Farm

Iddo Brenneman
572 Oak Dale Road,
Salisbury, PA 15558
P. 814-662-2010

Randy and Jamie Loch

143 Cokely Road, Springville, PA 18844
P. 570-965-2679 F. 570-240-1432
www.lochsmapple.com
maple4u@epix.net

Triple Creek Maple LLC

Gary Bilek
9225 Fillingier Road,
Cranesville, PA 16410
P. 814-756-4500
triplecreekmaple@yahoo.com

WEST VIRGINIA

Daniels Maple Products

Brandon Daniel
1747 Morris Brand Road,
Sawson, WV 25976
P. 608-625-6745 C. 304-575-7266
capholemaple@gmail.com
www.mapler@suddenlink.net

WISCONSIN

Adamski's Sugar Bush

James Adamski
W10923 Winter Road,
Antigo, WI 54409
P. 715-623-6853

Morley's Maple Syrup

141 W. 1st Avenue, Luck, WI 54853
P. 715-554-2301

Horner's Corner

1240th Avenue, Boyceville, WI 54725
P. 715-643-3711

Sugar Grove Maple Supply

Emmanuel Hershberger
S2030 County Road D,
Westby, WI 54667
P. 608-625-6745

Russ Schneives

737 Naugart Dr.,
Athens, WI 54411
P. 715-257-7713

Roger Bundy

N402 CTY RD D, Eau Galle, WI 54737
P. 715-495-0872

CORPORATE STORES, DISTRIBUTORS AND REPRESENTATIVES ONTARIO AND NEW-BRUNSWICK

ONTARIO

CORPORATE STORES

CDL Central Ontario

2907, Highway 11 N
Oro-Medonte (ON) L0L 2E0
P. 705-487-3331 F. 705-487-0460
Toll free. 1-800-959-9192
cdlatkinson@cdlinc.ca

CDL Eastern

3464 Station Street
Monkland (ON) K0C 1V0
P. 613-346-0333 F. 613-346-1333
cdleaster@cdlinc.ca

CDL Lanark

40 George Street
Lanark (ON) K0G 1K0
P. 613-259-5554 F. 613-259-2409
cdllanark@cdlinc.ca

CDL Western

3301 Perth Road, R.R.2
Staffa (ON) N0K 1Y0
P. 519-345-0259 F. 519-345-0350
cdlwestern@cdlinc.ca

DISTRIBUTORS

RMG Family Sugar Bush

11866 W. Thompson Road
Rudyard, MI 49780
P. 906-478-3038 F. 906-478-7830
C. 906-322-0765
mjross@lighthouse.net

Home Hardware Kentvale Landing

712, K-line Road
Richards Landing, On P0R 1J0
P. 705-246-2002 F. 705-246-2361
kentvale@bell.net

REPRESENTATIVES

George Roney

Brant, Bruce, Chatam-Kent, Dufferin, Elgin, Essex,
Haldiman, Hamilton, Huron, Lambton Middlesex,
Niagara, Norfolk, Oxford, Perth, Waterloo, West Grey,
West Willington Peel
george.roney@cdlinc.ca
c. 519-949-1954

Josh Holmes

Durham, East Grey, East Willington Peel, Halton,
Kawartha Lakes, Muskoka, Northumberland,
Peterborough, Simcoe, South Haliburton, Toronto,
West Parry sound, York
josh.holmes@cdlinc.ca
c. 705-229-7168 P. 705-487-3331

Steve Skinner

Frontenac, Grenville, Hasting, Lanark, Lennox & Addington,
Leeds, Ottawa, Prince Edward, Renfrew
steve.skinner@cdlinc.ca
c. 819-629-4157

Yan Gaudet

Cochrane, East Parry Sound, Manitoulin, Nipissing,
North Haliburton, Sudbury, Timiskaming
yan.gaudet@cdlinc.ca
c. 819-629-4157

Rob Berkvens

Glengarry, Prescott & Russell, Stormont Dundas
rob.berkvens@cdlinc.ca
c. 1-613-551-3333 P. 1-613-346-0333

NEW-BRUNSWICK

CORPORATE STORES

CDL St-Quentin

7, rue Canada
Saint-Quentin (NB) E8A 1J2
P. 506-235-9100 F. 506-235-2894
cdlstquentin@cdlinc.ca

CDL Acadie

1875, rue Bellechasse, Paquetville, (NB) E8R 1C6
P. 506-764-3280 F. 506-727-8699
cdlacadie@cdlinc.ca

REPRESENTATIVES

Marc Chiasson

Acadie
Marc.chiasson@cdlinc.ca
c. 506-727-8699

Yves Asselin

Nouveau-Brunswick Nord
yves.asselin@cdlinc.ca
c. 418-222-3367

Jacques St-Pierre

Nouveau-Brunswick (Nord-Ouest)
jacques.st-pierre@cdlinc.ca
c. 418-860-7447

Claude Fecteau

Nouveau-Brunswick (Nord-Est)
claudio.fecteau@cdlinc.ca
c. 418-865-3512 T. 418-865-4609



OPEN HOUSES

2017

QUÉBEC

Come
meet us in
Saint-Lazare

MAI
19-20-21
2017

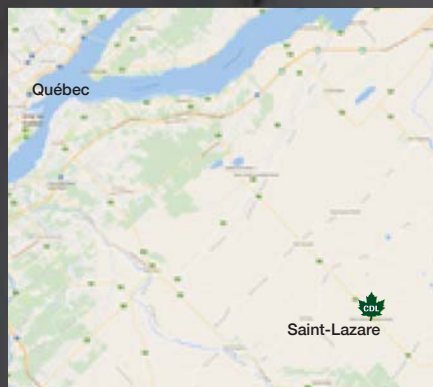

257, Route 279
Saint-Lazare-de-Bellechasse, Qc
Canada G0R 3J0
1-800-361-5158
www.cdlinc.ca

VERMONT

Come
meet us in
St. Albans

AVRIL
28-29
2017

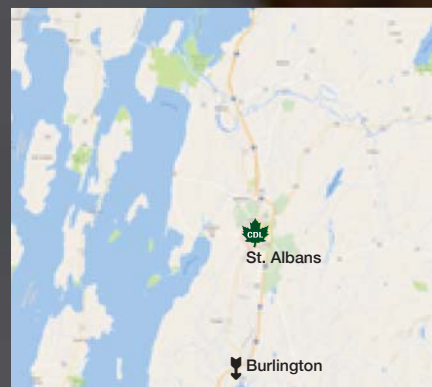

3 Lemnah Drive
St. Albans, Vermont
United-States 05478
1-800-762-5587
www.cdlnusa.net



cdlinc.ca



LES ÉQUIPEMENTS D'ÉRABLIÈRE CDL inc.

257, route 279, Saint-Lazare-de-Bellechasse, Qc G0R 3J0



cdlinc.ca